

# **Waltonchain White Paper**

**(V 1.0.4)**

Value Internet of Things (VloT) constructs a perfect commercial ecosystem via the integration of the real world and the blockchain

Ushering human beings into the reliable digital life

Waltonchain unfolds the new era of Value Internet of Things (VloT)

**By the Waltonchain Team**

**2018.02.08**

# Table of Contents

Part 1 Introduction — The concept of the Value Internet of Things.....	1
1.1 The Inevitable Trend of Internet Technology Innovation: The Value Internet of Things .....	1
1.2 The Blockchain Technology Development Trend: Rapid Expansion of Application Areas.....	3
1.3 The Technical Preparation to Create the Era of Value Internet of Things (VloT) Has Been Completed.....	5
Part 2 Journey — The Realization of Value Internet of Things.....	8
2.1 General Description.....	8
2.2 The hardware of the Value Internet of Things.....	8
2.2.1 What is RFID?.....	8
2.2.2 RFID tags .....	10
2.2.3 Introduction of UHF RFID ICs .....	11
2.2.4 Analysis on the Advantages and Disadvantages of International RFID ICs.....	12
2.2.5 The Overall Design of the RFID ICs of the Value Internet of Things .....	13
2.3 The Software of the Value Internet of Things.....	17
2.3.1 The Interpretation of WALTON .....	17
2.3.2 The Overall Structure of Waltonchain .....	18
2.3.3 Waltonchain Protocol and Waltoncoin .....	20
2.3.4 Waltonchain ecosystem .....	31
2.4 Application Scenarios: Waltonchain Project’s System Solutions for the Apparel Industry .....	35
2.4.1 Analysis on the Dilemma of the Traditional Apparel Manufacturing.....	36
2.4.2 Smart Manufacturing Solution for the Apparel Industry.....	37
2.4.3 Smart Logistics & Warehousing Solution for the Apparel Industry.....	39
2.4.4 Smart Store Solution for the Apparel Industry.....	41
Part 3 Future — Value Internet of Things Will Change the World.....	45
3.1 The Stage Planning of the Waltonchain Project.....	45
3.2 The Investment Value of the Waltonchain Project.....	48
Part 4 Project Foundation.....	51
Part 5 Team Introduction .....	54

第五部分 团队简介 .....	54
5.1 Initiators .....	54
5.2 Senior Advisors .....	55
5.3 Chief Experts .....	56
5.4 Team Members .....	57
5.5 Angel Investors .....	63
5.6 Consultant Team .....	64
Part 6 References .....	67

Wattonchain



---

# **Part 1 Introduction — The concept of the Value Internet of Things**

## **1.1 The Inevitable Trend of Internet Technology Innovation: The Value Internet of Things**

We are in an era where new technologies lead to social changes. In the age of information and the Internet, human collaboration and communication break through time and space constraints, and the world becomes an overall interactive platform.

In recent years, the Internet has entered a new business format of "Internet +". In this stage, a new form of economic and social development of "Internet + all traditional industries" driven by knowledge and social innovation 2.0 provides a broad network platform for the reform, innovation and development of various industries.

At present, the information age is entering an unprecedented important stage of development where the objects can be connected to each other through the Internet; this stage is called the third wave of the development of the world information industry following the computer and the Internet: the age of the Internet of Things (IoT). Internet of Things technology contains two meanings: first, the core and foundation of the Internet of Things is still the Internet, the Internet of Things is an extension of the Internet; second, the client side of the Internet of Things extends to the information exchange and communication between any objects, which is so called object-to-object interrelation.

However, from the Internet, to the "Internet +" and then to the Internet of things, all stages have failed to solve the problem of localization of information

---

dissemination (e.g. centralization). It is difficult for the Internet of things under the current central structure to accomplish the real autonomous cooperation and effective transactions, because the relevant parties of such cooperation and transactions often belong to different stakeholders with complex and uncertain trust relationship. Therefore, the collaboration and transactions of the current Internet of Things devices can only be carried out under the same trust domain, the devices to collaborate and trade must be provided or verified by the same Internet of Things service provider, which significantly reduces the true commercial value of the Internet of Things applications.

In this context, we put forward the concept of the “Value Internet of Things (VIoT)”, focusing on introducing the blockchain technology into the Internet of things, to solve the problem of centralization facing the development process of the Internet of Things. The blockchain is a decentralized transaction record & storage technology based on cryptographic principles; with a distributed point-to-point network, it can achieve the permanent storage of orderly transaction record which is undeletable, tamper-resistant, open and traceable, so it is recognized as the best choice to meet the above challenges. In the ecology of the blockchain, people can trade safely without trust established in advance, because every transaction is well recorded in the “public ledger” of the blockchain, which is a perfect solution to the trust and equity issues of the Internet virtual world. The inevitable trends of the Value Internet of Things are shown in Figure 1.1.



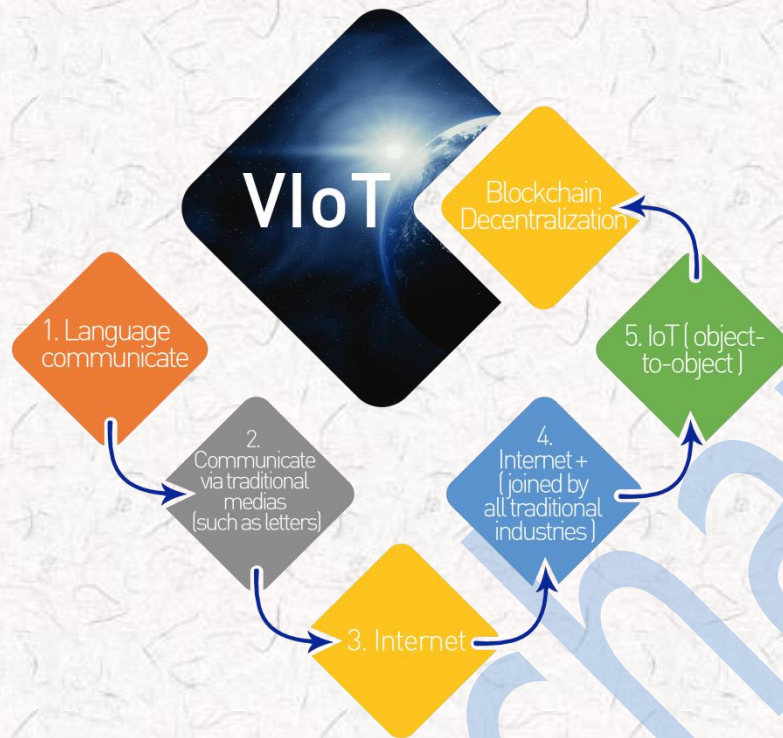

Figure 1.1: The inevitable trend of the Value Internet of Things

## 1.2 The Blockchain Technology Development Trend: Rapid Expansion of Application Areas

Bitcoin appeared in 2009 and began to circulate. The total market capitalization of Bitcoin has exceeded \$ 30 billion, making Bitcoin a successful application of the blockchain technology in the field of digital money. Ethereum introduced smart contracts to program the complex contract rules into the blockchain by way of code. Smart contracts can be automatically executed when the agreed conditions are reached, as a result, the field of application of the blockchain has been broadened; the representative Namecoin and Datacoin extended the object of the blockchain from the electronic money trading record in the era of Bitcoin to the domain name, user data and other fields.

---

As an organic component of the blockchain distributed implementation, the consensus mechanism has also undergone full development; as a result, several major consensus mechanisms have appeared:

**POW: Proof of Work, e.g. Work to Prove Consensus Mechanism, also known as the mining mechanism.** Bitcoin is first one to use the POW mechanism to dominate the block generation. The node continues trying to calculate the block hash value corresponding to each block ledger's content to satisfy a specific condition, that is, N zeros are used as the preamble. This will increase the difficulty of Block generation, significantly reducing the risk of correct subchains being replaced by quickly generated longer malicious subchains, but will also lead to the waste of many computing resources of the mining machines at the same time.

**POS: Proof of Stake, e.g. Stake to Prove Consensus Mechanism.** It is an upgrade of the POW consensus mechanism to control the length of mining time based on the number of the tokens and the holding time of the node; it can effectively reduce the mining time, but still cannot avoid the problem of wasting the computing resources of the mining machines.

**DPOS: Delegated Proof of Stake, e.g. Delegated Stake to Prove Consensus Mechanism.** Its principle is that tokens select a certain number of nodes by voting to complete the verification and accounting work for them. This consensus mechanism can greatly reduce the number of nodes involved in accounting and verification to achieve rapid consensus verification, but it also relies on the existence of the tokens, so that some applications that do not require tokens will be limited.

**PBFT: Practical Byzantine Fault Tolerance.** It is a consistency algorithm by message transmission that achieves consistency through three phases to determine the final block generation. If there are  $3f + 1$  nodes, this algorithm can tolerate the existence of  $f$  error nodes, so that the consistency results will not be



---

affected. This mechanism can be divorced from the existence of coins, the consensus node can be determined by participants and regulators, and 2—5 seconds of shared delay are basically able to meet the commercial requirements.

Various consensus mechanisms have their own considerations and significance in terms of their respective business scenarios and technical means. When compared to each other, they have different improvements and enhancements in different aspects, as well as different disadvantages, so there seems to be no optimal consensus mechanism. Achieving the pluggable applications of various consensus mechanisms, choosing the right consensus mechanism according to the specific application scenario and optimizing the application of blockchain shall be the best way for further application in more fields.

Various trends indicate that blockchain technology is expanding its application to more and more areas, such as digital money and smart contracts, while the earlier relevant technologies failed to break the connection barrier between the virtual network and the real world. Applying the blockchain to the Internet of Things and smart systems and connecting the item tags and identity tags in the real world to the virtual network via RFID technology will successfully build this connection, ultimately achieve the interconnection of all things and create the era of Value Internet of Things (VloT).

### **1.3 The Technical Preparation to Create the Era of Value Internet of Things (VloT) Has Been Completed**

Traditional Internet of Things (IoT) is a network which enables all the common objects that can perform independent functions to be interconnected. It connects the sensors, controllers and objective entities through network technology to realize intelligent management and control. For example, through radio frequency



---

identification (RFID), infrared sensors, global positioning systems, laser scanners and other information sensing equipment, it connects any item to the Internet to carry out information exchange and communication according to the agreement, to achieve intelligent identification, positioning, tracking, monitoring and management. As an extension of the Internet, the Internet of Things further promotes the connections between machine and machine, human and machine and achieves the full life cycle circulation management of data in the information world.

With the continuous advances of technology, the development and application of the Internet of Things technology have achieved remarkable results in recent years. There are already billions of sensors and smart controllers put into use so far, and the number of the sensors and smart controllers is expected to grow in the next few years. However, the Internet of Things technology is also facing many problems and challenges which may become great obstacles for the future development and application of the Internet of Things. The era of the Value Internet of Things led by RFID and blockchain technologies can provide solutions to these problems.

The technical realization of the Value Internet of Things means connecting the items tags, event tags, people and body tags and other entity tags in the real world with the virtual world of the Internet through the underlying hardware platform using the RFID tags as the core, combined with the blockchain technology delivering value and constructing trust, to achieve the real interconnection of all things.

The speed of transition from the Information Internet and traditional Internet of Things to the Value Internet of Things based on RFID and blockchain technology may be far beyond the current expectations. When the Value Internet of Things

---

**achieves the real interconnection of all things, the RFID and blockchain technology will play a greater role.**

Wattonchain

---

## **Part 2 Journey — The Realization of Value**

### **Internet of Things**

#### **2.1 General Description**

The whole system of the Value Internet of Things can be divided into two parts: hardware and software. The hardware includes the RFID tag chips and the RFID reader chips. The RFID tag acts as the interface for all assets to be connected to the chain, and the reader chip is a bridge for all assets to be connected to the chain and can be used as a node on the chain. The software includes the Waltonchain software system, the Waltonchain protocol and Waltoncoin. With the combination of software and hardware, the Value Internet of Things can really achieve the connection of all things to the chain and the digitalization of all assets.

#### **2.2 The hardware of the Value Internet of Things**

##### **2.2.1 What is RFID?**

The Radio Frequency Identification (RFID) technology is a communication technology that can identify specific targets and read and write relevant data through the radio signals without building a mechanical or optical contact between the recognition system and specific targets. RFID readers are divided into mobile readers and fixed readers. At present, RFID technology is widely used, for example, in library access control systems, for food safety traceability, etc.

The radio frequency tags are the physical carrier of the electronic product code (EPC) which are attached to traceable items, identifiable, readable and writable and can be circulated all over the world. As a key technology for constructing the "Internet of Things", the RFID technology has received attention



---

in recent years. The RFID technology originated from the United Kingdom, it was used in the Second World War to identify friend or foe aircraft. Its business application began in the 1960s. The RFID technology is an automatic identification technology. The US Department of Defense states that all military supplies must use RFID tags since January 1, 2005, and the US Food and Drug Administration (FDA) recommends that the pharmaceutical companies use RFID to trace drugs easy to be faked since 2006. By using the RFID technology, Walmart and Metro retailers have further promoted the application of RFID in the world. In 2000, the price of each RFID tag was \$1. Many researchers believed that RFID tags were very expensive, large-scale application could be realized only when the price went down. In 2005, the price of each RFID tag was about 12 cents, and now the price of each UHF RFID tag is about 10 cents. To achieve large-scale application of RFID, on the one hand, it is necessary to reduce the price of RFID tags, on the other hand, it depends on whether the application of RFID can bring value-added services. Eurostat statistics show that in 2010, 3% of the EU companies used RFID technology for identity documents and access control, supply chain and inventory tracking, car charges, security, production control and asset management, etc. Since 2010, due to the improvement of economic situation, the development of the Internet of Things industry and other positive factors, global RFID market continues to heat up, RFID technology has been applied to a growing number of fields, and people have had higher expectations for the development of RFID industry. The RFID technology is in a period of rapid maturity, many countries are actively promoting RFID as an important industry.

Although the prices of passive UHF electronic tags fell rapidly in the past two years, the prices of UHF RFID systems are still high relative to the overall cost of RFID chips, including readers, electronic tags, middleware, system maintenance, etc. And the cost of UHF RFID system is an important indicator for clients to

---

estimate the return of investment. The bottleneck caused by high cost has become an important factor restricting the development of UHF system market.

In short, the passive UHF market is still in its early stage of development. Thus, the core technology needs breakthroughs, business models need to be innovated and improved, and the industry value chain needs to be further developed and extended. Only when the core issues are effectively resolved, can we embrace the real development of RFID passive UHF market.

### 2.2.2 RFID tags

The RFID tag contains the stored electronic information. The tag does not need to be within the sight of the recognizer, and it can be embedded in the tracked object. RFID tags include passive tags and active tags.

**Passive tags:** can get energy from the electromagnetic field emitted by the reader, no battery required.

**Active tags:** the tag itself has power supply and can automatically send radio waves.

Figure 2.1 shows the actual application scenario of RFID.



Figure 2.1: The actual application scenario of RFID



### 2.2.3 Introduction of UHF RFID ICs

After years of development, the RFID technology of 13.56 MHz or less has been relatively mature. At present, the industry pays most attention to the UHF RFID which operates in the frequency range 860 to 960 MHz. Its advantages are fast reading and writing, multi-target recognition, non-line-of-sight recognition, mobile positioning and long-term tracking management, long effective range (usually 3 to 10 m) and fast communication speed. UHF RFID technology has become a hot spot in the development of the industry, and passive UHF RFID tags and systems grow rapidly.

The built-in RFID IC of UHF recognizer (reader and writer) is a core component that provides readability to the recognizer. On the receiving end the Received wireless useful signal is amplified by LNA, mixed by I/Q mixer, filterer, converted by ADC, and finally inputted to the MCU; on the transmitting end the signal outputted from the MCU is mixed by I/Q mixer, amplified by PA and transmitted to the antenna, finally transmitted to the tag. Figure 2.2 shows the structure of the RFID IC of UHF recognizer (reader and writer).

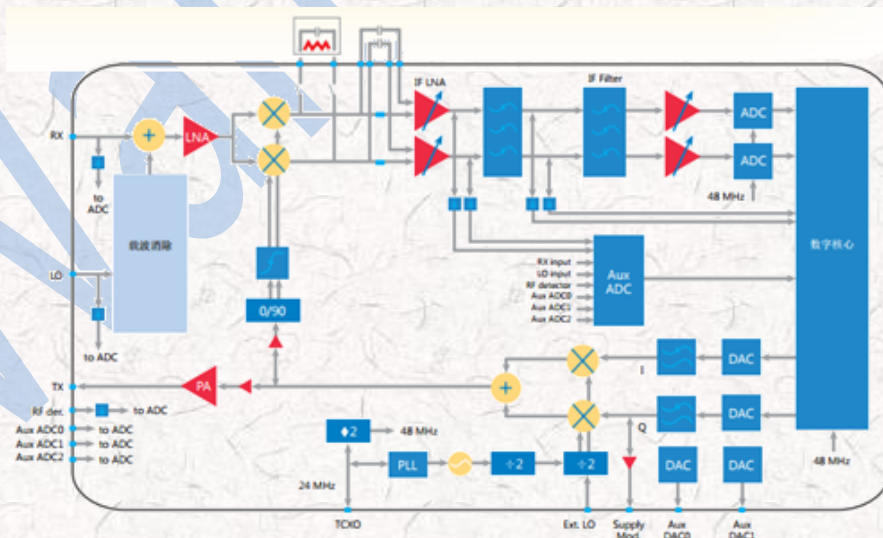

Figure 2.2: UHF recognizer (reader and writer) RFID IC structure diagram



UHF Tag IC: is a core component that provides memory and performance for tags. It manages the received wireless signal as energy, transmits the stored memory data to the antenna after the carrier modulation. Figure 2.3 shows the structure of the UHF RFID tag IC.

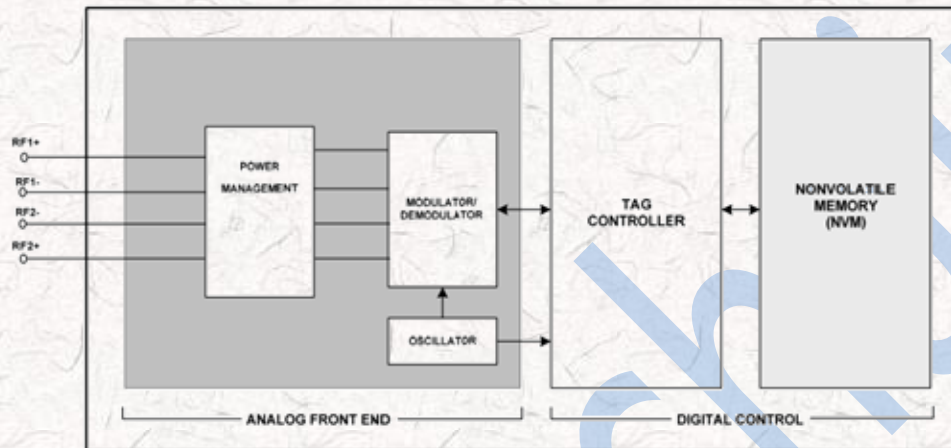

Figure 2.3: UHF RFID tag IC structure diagram

## 2.2.4 Analysis on the Advantages and Disadvantages of International RFID ICs

Reader ICs: due to the huge market attractiveness, many manufacturers have been involved in the relevant technology research, development and production, bringing on an upsurge of radio frequency identification technology. Based on the increasing investment in research, the RFID technology has made great progress in core hardware technology, public service platform and testing and standard. International companies have achieved many technical improvements of RF front-end, analog front end, digital baseband and storage unit of the multi-band radio frequency identification; the mainstream manufacturing process has reached 0.13 microns or less and achieved the mass production of low-power technological chips, such as R2000 by Impinj: its reception sensitivity has reached  $-80$  dBm (10 dBm self-interference) with a transmission power of 31.5 dBm. Although the performance is excellent, the price is very high.

---

**Tag ICs:** as for the tag chip technology, the developed countries already have a relatively complete product line. With the continuous development and improvement of technology and market, the electronic tag technology continues to improve, and the industrial application of technology has entered a stage of vigorous development. The class 0 design by Alien has laid the foundation for the implementation of the first generation RFID standards. Compared to the first generation standards, the second generation EPF tag IC has many advantages: its center frequency reaches 900 MHz band, greatly improving the recognition rate to 500 to 1500 tags/sec; its backscatter data rate can be increased from tens of bits per second to 650 kbps; its scan range has increased to 30 feet. Now in the market and the laboratory, the second generation UHF RFID tag ICs with more excellent features have appeared, for example, Impinj's Monza 4 RFID tag IC has reached a more advanced level. Its outstanding performance mainly reflects in extensible memory options, innovative secrecy function, good anti-jamming capability and industry-leading sensitivity properties.

But the existing RFID chip industry cannot meet the development of Internet of Things applications, especially applications for the Value Internet of Things: there are few options available while the prices are high; the transmission power and stability need to be improved; the reception sensitivity is low, the anti-interference ability is poor and the transmission power is low. In addition, the existing RFID ICs have many problems such as high power consumption, poor matching with antenna and difficult system integration, etc.

## **2.2.5 The Overall Design of the RFID ICs of the Value Internet of Things**

The project includes RFID tag IC and reader IC suitable for blockchain technology applications. The ICs are characterized by integrated elliptic curve and



---

decryption acceleration module based on the existing RFID technology and a communication interface protocol suitable for blockchain technology applications. The implementation of the project will promote the application of blockchain technology in the Internet of Things and solve the following problems in the current application of blockchain technology:

1. Each tag does not need to store node data, only need to be responsible for signature verification;
2. Tags automatically generate random public keys and private keys to ensure the security of Internet of Things applications, to ensure that the tag is unique, authentic and tamper-resistant;
3. Tags can reduce the amount of information stored to solve the problem of blockchain overload by large amounts of data in the Internet of Things applications;
4. Tags can solve the problem of slow encryption and decryption in asymmetric encryption technology;
5. Tags can help truly achieve the decentralization of property management and asset management so as to make the data tamper-resistant.

RFID reader IC is one of the core components of the reader, containing the RF section and digital signal processing section. On the receiving end the signal is amplified by LNA, mixed by I/Q mixer, filterer, converted by ADC and finally inputted to the digital processing section; on the transmitting end the digital signal outputted from the digital processing section is converted by ADC, mixed by I/Q mixer, amplified by PA and transmitted to the antenna, finally transmitted to the tag.



---

The RFID tag IC contains the RF section, power management section, digital signal processing section and storage section. The power management section contains electromagnetic coupling, energy storage, LDO and other circuits. It converts the received wireless signal into electrical energy to power the tag. In the transmitting section, the stored memory data is transmitted to the antenna after carrier modulation.

Though the RFID reader IC market demand continues to increase, the existing technology still has some aspects to be improved, such as the number of tags identified simultaneously, misreading, high power consumption, etc. The project provides a new design solution for the application problems and a chip architecture solution with core competencies, combined with the application of blockchain technology.

Figure 2.4 and Figure 2.5 show the block diagram of the reader IC and the tag IC, respectively. The RFID tag IC design integrates innovative encryption capabilities, so it's suitable for blockchain technology applications and has a good anti-interference ability and sensitivity index. Its demanding power design can meet the current stringent requirements for power consumption, and the on-chip antenna technology and antenna matching technology have been significantly enhanced to improve the performance.

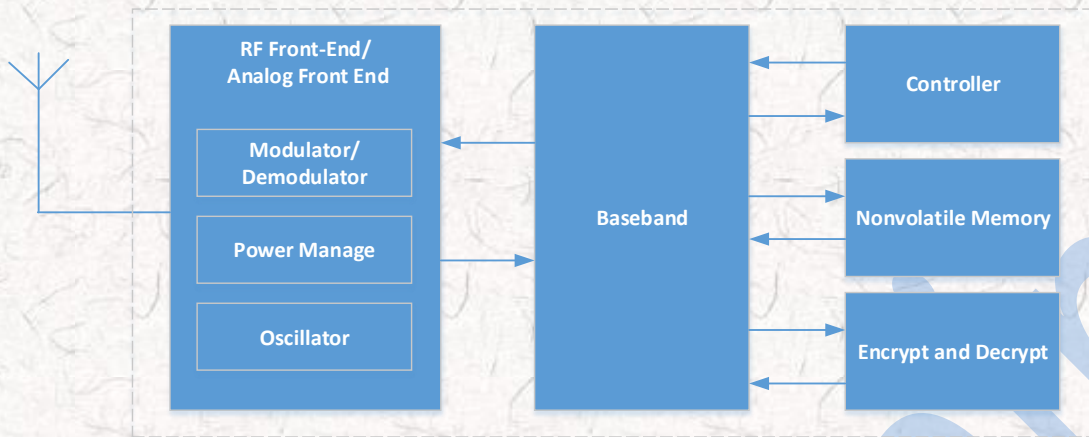

Figure 2.4: The project's reader IC solution block diagram

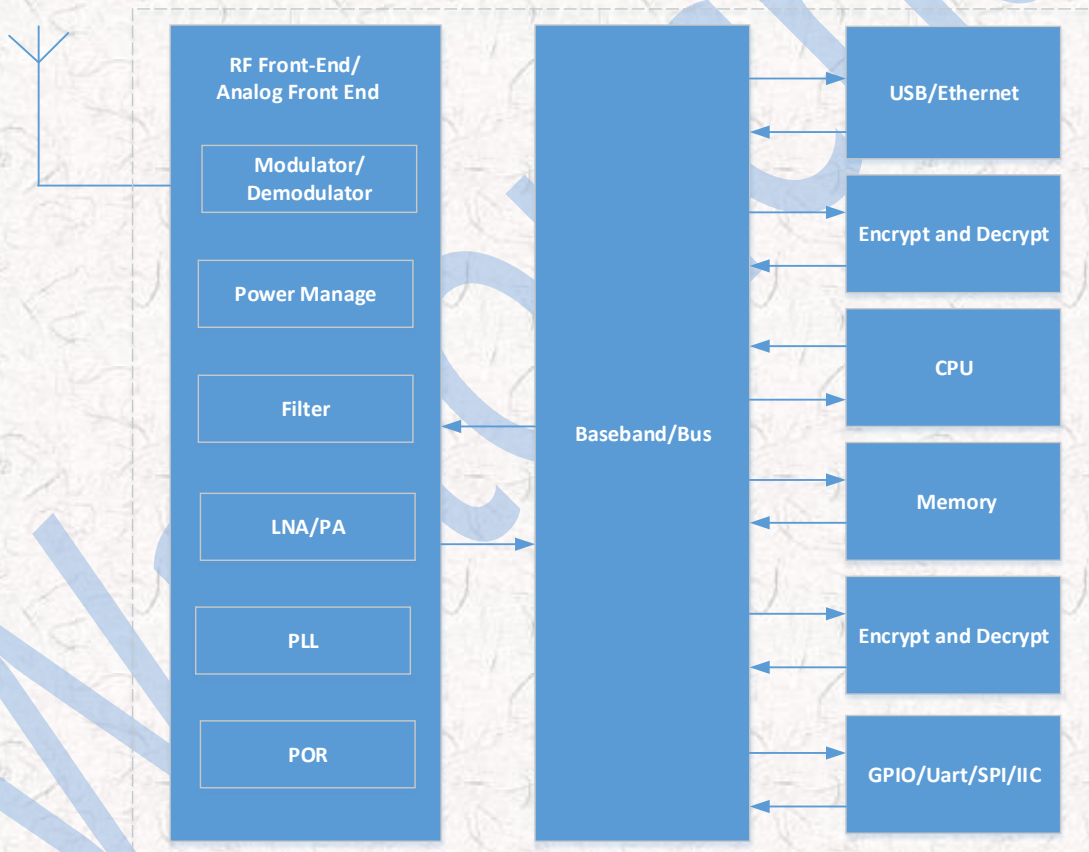

Figure 2.5: The project's tag IC solution block diagram

The project's IC design has the following significant advantages:

- 
- 1) **High security:** The chip integrates asymmetric random password pair generation logic, uses a core asymmetric encryption algorithm with independent intellectual property rights and an optimized design without increasing the cost and power consumption of the chip, enabling higher communication security;
  - 2) **Optimized anti-collision design:** The chip uses a binary tree anti-collision algorithm with independent intellectual property rights and a time division multiple access design, significantly improving the tag recognition success rate and the number of identifiable tags at the same time;
  - 3) **High sensitivity:** The chip uses an optimized noise suppression technology to improve the noise factor at the receiving end and the overall receiver sensitivity, which plays an important role in increasing the recognition success rate; all these features enable the chip to have a greater advantage in application in the Internet of Things.
  - 4) **Good compatibility:** The chip can achieve high-frequency and ultra-high frequency functions at the same time, the end customer can read the information and inquire about reliable product information through a smartphone.

## **2.3 The Software of the Value Internet of Things**

### **2.3.1 The Interpretation of WALTON**

**WALTON is derived from Charlie Walton, who was born in California, died on November 30, 2011. As the inventor of RFID technology, he devoted his life to the development of RFID technology. He obtained the first patent related to RFID technology in 1973 and eventually obtained more than 50 invention patents. He started a new era of RFID and made outstanding contributions to the development**



---

of RFID. At present, RFID technology is widely used in various applications all over the world, from identification to freeway billing, mobile and credit card payment; we can see RFID everywhere. The project was founded on November 30, 2016, the fifth anniversary of the death of Charlie Walton. To commemorate the great inventor of RFID technology, the project was named "Waltonchain" to carry forward his invention and blaze a trail to the future.

The interpretation of WALTON is as follows:

**WALTON = Wisdom Alters Label, Trade, Organization and Network.**

**W — Wisdom**

**A — Alters**

**L — Label: RFID label**

**T — Trade: trade mode based on the accounting mode of blockchain**

**O — Organization: Organizational management model — decentralized autonomous organization (DAO)**

**N — Network: the Internet of Things — P2P network mode**

### **2.3.2 The Overall Structure of Waltonchain**

The Waltonchain ecosystem uses an overall structure including a parent chain and subchains (or child chains) where the parent chain is Waltonchain and the token used for circulation and payment is called Waltoncoin. During the 1.0 stage of the project, the parent chain — Waltonchain — is used to open up a complete supply chain system of the apparel industry, including production, logistics, warehousing and stores. Theoretically, there can be an infinite number of subchains. For example, recognizers of a production workshop used to monitor product quality can be used as nodes of a production subchain, and the production workshops of a variety of brands together constitute the production subchain. For

---

another example, stores of a variety of apparel brands can constitute a sales subchain.

The Waltonchain platform uses a hierarchical structure, including the bottom layer, core layer, middle layer and application layer; the platform architecture is shown in Figure 2.6.

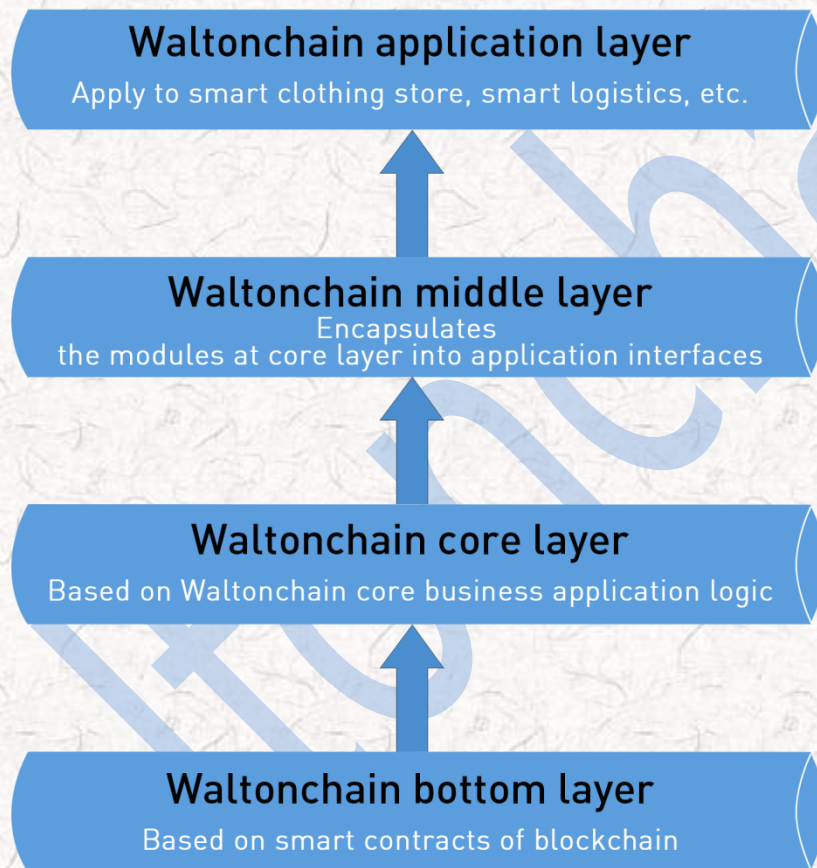

Figure 2.6: Waltonchain platform structure

### Waltonchain Bottom Layer

The bottom layer is developed based on Waltonchain. Waltonchain has many advantages, please see the introduction of Waltonchain for details.

---

## **Waltonchain Core Layer**

Waltonchain is developed based on the universal blockchain technology. To meet common and individual requirements of different applications, the core layer will include common and personalized features as a package to form core modules of different applications.

## **Waltonchain Middle Layer**

For different applications, Waltonchain has dedicated and common interfaces to call for the application layer. The middle layer is used to achieve the package of these interfaces, thus simplifying the work of the application layer and reducing the application difficulty.

## **Waltonchain Application Layer**

As for the top-layer content, users or the Waltonchain team can develop an appropriate platform or environment based on different application scenarios to meet individual, team or business needs of an application.

### **2.3.3 Waltonchain Protocol and Waltoncoin**

#### **The detailed structure of Waltonchain**

The detailed structure of Waltonchain is shown in Fig. 2.7 below. Clothing industry application was selected as an example to show the subchain structure.



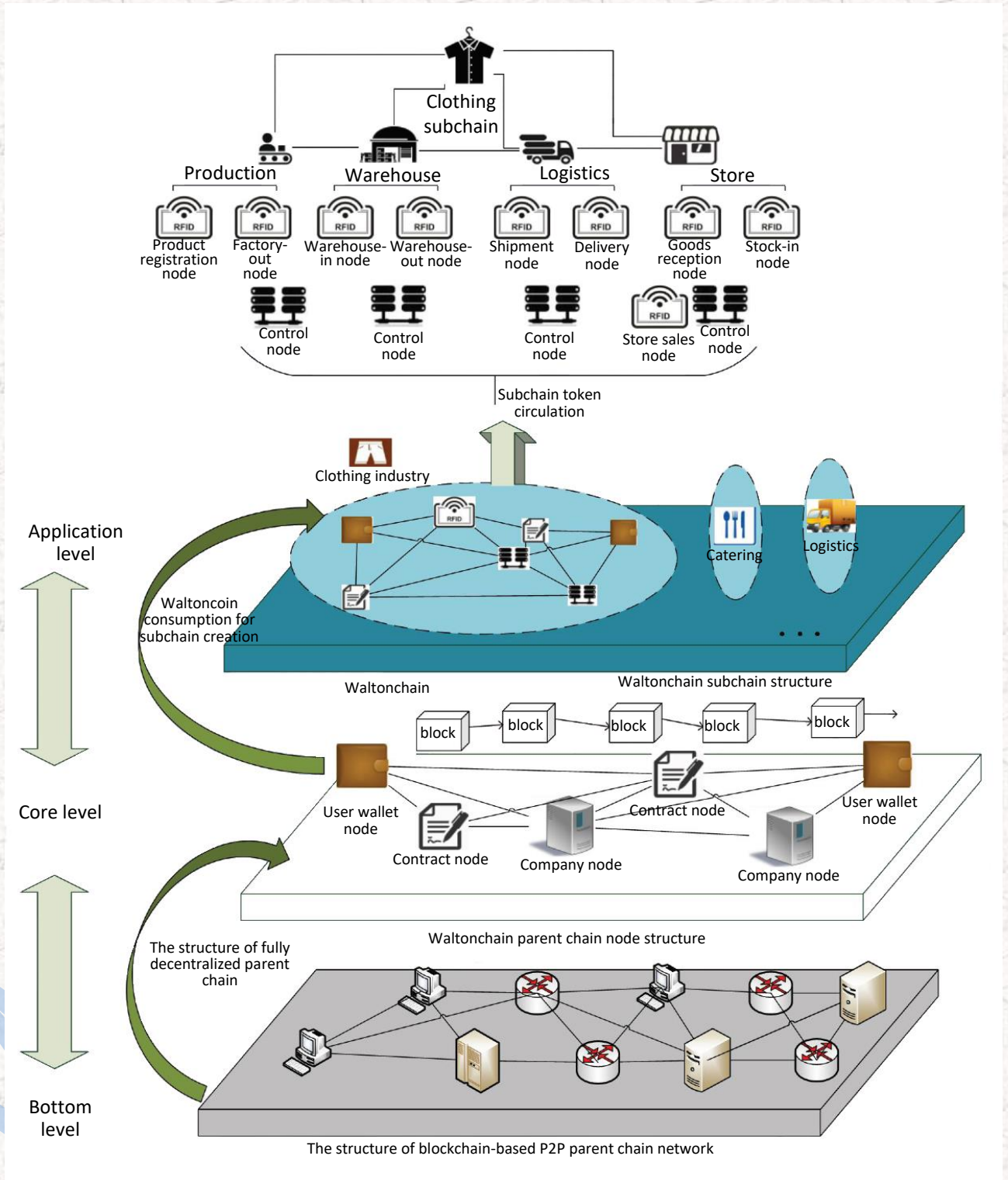

**Figure 2.7: The detailed structure of Waltonchain**

---

## **Waltonchain Parent Chain**

The Waltonchain parent chain is the main chain of the Waltonchain blockchain, starting from the Waltonchain Genesis Block, which provides a wealth of functions including but not limited to Waltoncoin (WTC) transaction management, subchain management, smart contract, alias and account control, etc.

### **1) transaction management**

A total of 100 million of WTCs are issued, created in the genesis block and assigned to each account in accordance with established program. The total amount of WTCs in the subsequent transactions remains the same. Through the decentralized network, more accounts will be created through the nodes, and a lot of WTC transactions will also be carried out between the accounts. Every 60 seconds, all the transactions during the current period will be recorded to a block, linked to the previous block, forming the Waltonchain parent chain. The parent chain is the public ledger of WTC transactions stored dispersedly in nodes in the network to ensure safety and reliability of transaction data.

### **2) subchain management**

Another major function of Waltonchain parent chain is the management of subchain which can be created by any account at any time after the parent chain runs. The creator can customize the detail functions of the subchain and specific information of the subchain tokens. This custom information forms the data structure describing the subchain, which is recorded in the block of the current period by the accounting nodes in a way similar to the WTC transaction record. So far this subchain will be used as a separate blockchain, recording the transactions of the subchain tokens.

---

Since the WTC transactions are only recorded in the parent chain, the parent chain runs independently of the subchain. The nodes running on the parent chain only need to save the parent chain data to conduct consensus and validation of WTC transaction blocks. This flexible creation mechanism of WTC subchain makes subchains scalable, the state of subchains has no effect on the completeness and safety of the parent chain; except for recording the subchain description information, the number of subchains will not increase the size of the parent chain.

### **3) smart contract**

In the system architecture of the Waltonchain blockchain, the smart contract based on its programmable features is responsible for building the underlying logic platform and supporting the operation of the upper architecture layers, namely the core layer, the middle layer and the application layer. It is the cornerstone of Waltonchain, which enables it to develop a wider range of custom applications.

Smart contract technology is developed by Ethereum and has been applied in the electronic token release, electronic crowdfunding, electronic contracts, electronic equity distribution and other fields. The Waltonchain blockchain technology defines two types of account concepts: one is the general account storing the tokens; the other is the smart contract account storing smart contract procedures. When a transaction is sent to the smart contract account address, the corresponding smart contract procedure will be triggered and implemented. The procedure will use the data of the received transaction, the data stored in this account and the current block status data as input data, will perform the customized operations, make transaction requests, modify the account status data and execute other result behaviors.

### **4) other functions**



---

**Decentralized asset transactions: supporting the decentralized asset transactions of the parent chain WTCs and subchain coins;**

**Decentralized grading system: grading according to the performance of the account nodes' trading behaviors such as mortgage;**

**Decentralized alias system: facilitating the realization of the transactions by alias;**

**Account control;**

**Voting system;**

**Cross currency transactions;**

## **Waltonchain Subchain**

### **1) subchain functional features**

**During its creation, a subchain can be customized to support all the functional features of the parent chain, or can be limited to certain functional features to achieve the customization of the appropriate features. The supported custom features mainly include subchain token transactions, subchain token and parent chain token transactions, cross subchain token transactions, smart contracts, aliases, voting system, account control, instant messaging and data storage.**

### **2) subchain token transactions**

**By customization, the subchain can support subchain native token transactions, subchain token and parent chain token transactions and cross subchain token transactions. When a cross token transaction is made, the holder of the token makes a transaction request, the transaction request information contains the transaction type (buy or sell), the local token type, the target token**

---

type, transaction price and the number of transaction tokens. Then the Waltonchain protocol will match the buy and sell transactions in a decentralized way, which is open, fair, reliable and traceable compared to the traditional trading centers.

## **Block Structure**

The trading ledgers of WTCs are stored in the Waltonchain blocks that are series connected, forming the Waltonchain parent chain and subchains. These blockchains are stored in many nodes on the Waltonchain network, making the WTC transaction records open, safe, decentralized, traceable and tamper-resistant. The core component of this ambitious, secure and decentralized data structure is the block data structure designed by the Waltonchain team. It provides the parent chain with the features of safe, stable and fast response and provides subchains with a flexible combination of features, so as to adapt to a variety of Internet of Things applications and to match customized business models.

A Waltonchain block can contain up to 255 transaction records. Each transaction record contains a header carrying the identification information. The general information contained in the block is as follows:

**Block depth and timestamp**

**Block identity**

**Block account ID and public key**

**The identity of the previous block and the hash value**

**The total number of tokens of the transactions contained in the block and byte fee**

**The transaction information contained in the block**

---

**Block payload length and payload hash value**

**The generated signature of the block**

**Accumulated coinage difficulty of the block**

## **Consensus Mechanism**

### **1) PoST Consensus mechanism**

**The Waltonchain parent chain conducts block consensus and validation based on the Proof of Stake & Trust (PoST) consensus mechanism. PoST is an innovative updated version based on the Proof of Stake (PoS) consensus mechanism.**

**The traditional PoS is a distributed consensus algorithm, which is an upgraded version of the Bitcoin Proof of Work (PoW) consensus algorithm. In the PoW consensus algorithm, the nodes involved in the consensus need to continue trying to solve the problem of cryptography, to confirm the transaction, then write into the block and get tokens as a reward. In most cases, this reward comes from the unallocated tokens, so the process is vividly called mining. Because the mining is more and more difficult as the “mineral resources” reduce, a lot of computing resources tend to be wasted. In the blockchain network based on the PoS consensus algorithm, in most cases, all the tokens are issued from very beginning, then the block is successfully created and written into the accounting nodes of the blockchain; the accounting reward is the byte fee paid by the transaction initiation node, so the consensus mechanism is vividly called coinage. The more the tokens held by nodes are involved in the consensus and the longer the time to hold the tokens is, the bigger the opportunity to successfully complete the block creation and writing are. This mechanism greatly reduces the operation difficulty of accounting, saves valuable computing resources and at the same time provides a**



---

mechanism of selecting “good” accounting nodes to strengthen the security of the blockchain.

Waltonchain constructed an innovative node reputation evaluation system which added a node reputation mechanism to adjust the difficulty of coinage based on PoS and highlight the importance of reputation in business ecology, and creatively designed the PoST consensus mechanism. This consensus mechanism brings two positive effects: first, based on the commercial credit link of a combination of Waltonchain blockchain and RFID, it can further promote and train the integrity behaviors of the involved nodes through the information evaluation mechanism, for example, keeping good credit record in credit mortgage and other transactions, to cultivate a healthy business ecology; second, it provides an upgraded selection mechanism to choose more honest “high quality” nodes as coinage nodes, improving the security of the blockchain.

## 2) Other consensus mechanisms

The flexible structure of Waltonchain blockchain determines that the subchains can choose PoS, PoST or other consensus mechanisms to achieve the optimal application effect in different application scenarios.

By issuing different subchains, Waltonchain connects different types of Internet of Things nodes to apply to various scenarios in the business ecology. Due to the diversity of the Internet of Things, sometimes the Internet of Things needs many nodes online at the same time, which is quite different from the Internet, so we propose an innovative solution which sets the consensus mechanism flexibly based on the different application scenarios, to meet different application requirements.

---

## Byte Fee Allocation

The byte fee is the cost paid by the transaction initiation node to the accounting node, which is used to pay for the occupancy of network bandwidth and blockchain bytes in the process of paying the transaction. The accounting node can set the minimum cost that can be accepted, and the transaction initiation node can set the maximum cost to be paid. When both conditions are met, the transaction will be successfully written to the blockchain.

The byte fee is the source power driving the blockchain to account, as the accounting node performs block calculation and consensus verification to obtain the byte fee; the node needs to pay the transaction surcharge to initiate the token transaction and the subchain creation.

### 1) allocation of byte fee for token transactions

Waltonchain supports parent chain token transactions, subchain token transactions and cross-chain token transactions. When dealing with various types of token transactions, the transaction initiation nodes need to pay the byte fee with parent chain tokens. This can make the parent chain token become the single token used as a reward token of the parent chain accounting node and the subchain accounting node, finally achieving the following two positive effects.

First, the parent chain and each subchain can share the accounting nodes in the network to the maximum, so that the accounting nodes will freely choose different parent chains and subchains based on the profit efficiency, without fear of inconvenient exchange and paying multiple byte fees, which is beneficial to the reasonable allocation of the node resources. And for some of the subchains in the early stages of the establishment, there is no need to worry about the problem of insufficient accounting nodes, because they can share the accounting nodes of the parent chain and other subchains.



---

Second, when more subchains are created and the subchain transactions become more and more frequent, the demand for the parent chain tokens which are used as the currency to pay for byte fees will rise; since the number of the parent chain tokens remains the same, the value of each parent chain token will increase. As a result, the nodes holding the parent chain tokens will gain an interest from subchain development as the number of the subchains and transactions increases.

## 2) allocation of byte fee for subchain creation

The Waltonchain parent chain supports the creation of subchains. When creating a subchain, the account that creates the nodes needs to pay the byte fee with parent chain tokens, to prevent the malicious creation of many subchains. Parent chain tokens will be obtained as a reward for writing the block containing the description of this subchain into the accounting node of the blockchain.

## Waltoncoin

As mentioned above, in the Waltonchain ecosystem, the most core parent chain is called Waltonchain in which the token used for circulation and payment is called Waltoncoin (hereinafter referred to as WTC). WTC is the most important digital token in the Waltonchain ecosystem. The total number of WTCs is 100 million ( $10^8$ ), they were created and are located in the Genesis Block. This number is constant, and no more tokens will be issued.

## Waltoncoin's Main Functions

### 1) issuing subchains

WTCs need to be consumed to issue subchains, such as the production subchain, the storage subchain, the logistics subchain and the sales subchain. Of



---

course, issuing subchains is not the privilege of the Waltonchain team, as any Waltonchain ecosystem user can consume WTCs to issue its own subchains in the Waltonchain ecosystem.

The consumed WTCs are allocated to the accounting node wallet to support the parent chain. This is how the PoST mechanism is realized.

## 2) reward interest distribution

Waltonchain team officially issues basic subchains, such as the sales subchain used in stores (assuming the token is A coin) and the transaction subchain used in the retail industry (assuming the token is B coin). In the above high-frequency circulation sections, even if the transaction fee for each transaction is very small, many small fees can add up to a substantial number. Therefore, in order to ensure the robustness of the subchains and the parent chain at the same time, the allocation mechanism regarding the consumed fees needs some innovative adjustments. The majority (e.g. 90%) is assigned to the accounting node wallet of the subchains, and the minority (e.g. 10%) is assigned to the accounting node wallet of the parent chain.

## 3) credit and mortgage system

The account on the parent chain can form a credit mechanism. As the circulation and consumption amount of subchains increases, the credit rating of the corresponding account of the parent chain increases. Here is an application scenario: a customer needs to pay for his consumption at A store, A store supports A coins, but the customer does not have any A coin, then the customer can pay by mortgaging parent chain WTCs (in a frozen state), A store and the customer sign a smart contract on the chain automatically to set an agreed time to return A coins when such WTC coins will be unfrozen. Correspondingly, the credit rating of this account increases and the number of WTCs needed for mortgage decreases.

---

However, if the A coins fail to be paid back, the number of WTCs frozen for mortgage will increase correspondingly.

**4) distributed asset exchange**

If we exchange assets on the parent chain, the parent chain will be able to exchange the assets of any subchain tokens on any subchain. This allows the subchains to interact with each other and opens up many collaboration opportunities to allow cross-chain asset transactions, which is also a required function in the Waltonchain ecosystem in the long term.

**5) distributed voting and governance system**

This system will be the core of decentralization in the future. Safe and anonymous voting will be available for all subchains on the parent chain.

**6) decentralized exchange**

All the coins on the subchains can be traded in the decentralized exchange on the parent chain, where the digital currency used to act as an intermediary is WTC.

Of course, only some of the core functions of WTC are mentioned above. WTC has more functions, and as the project progresses, the Waltonchain team will give WTC more advanced features.

### **2.3.4 Waltonchain ecosystem**

An example of Waltonchain ecosystem application for the apparel industry is shown in Figure 2.8 below.

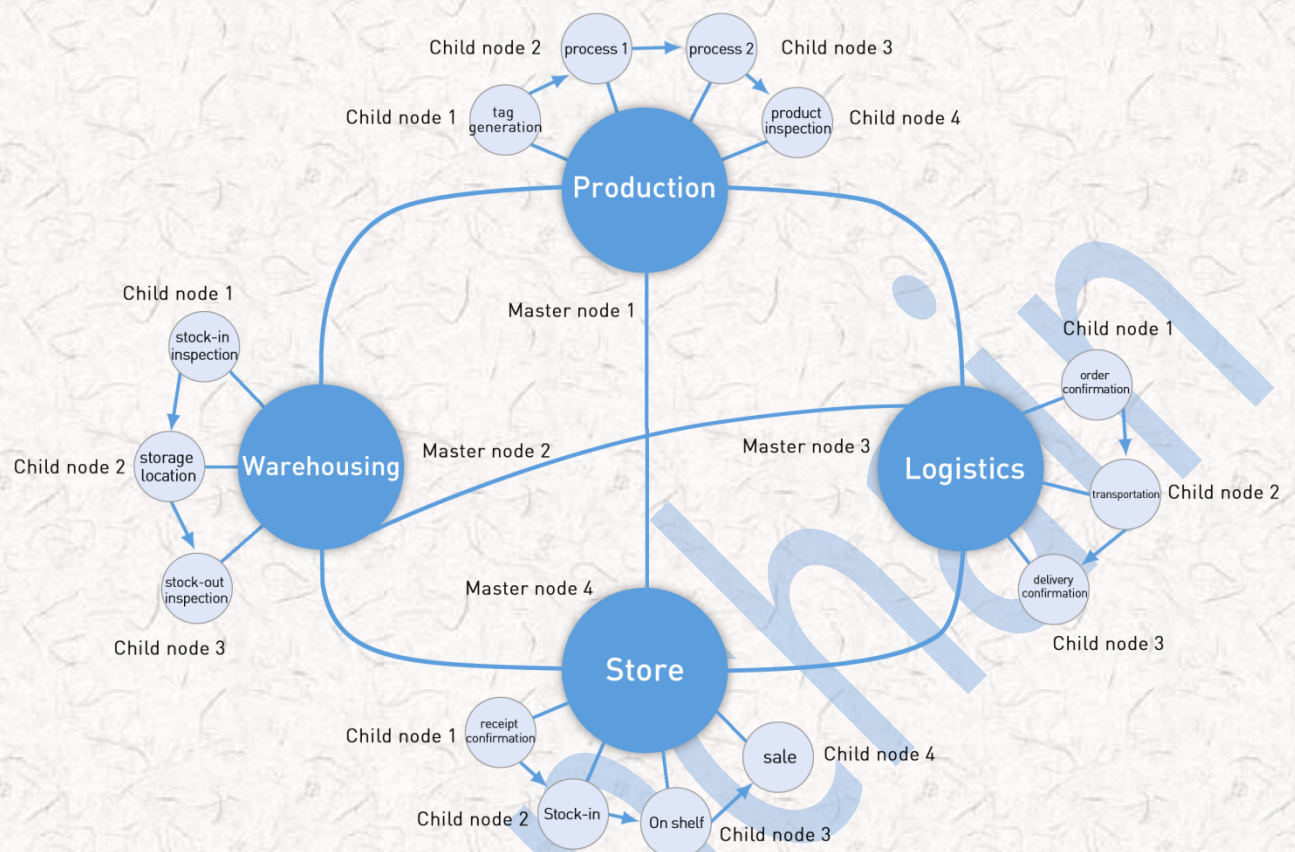

**Figure 2.8: Waltonchain ecosystem 1.0 stage**

The whole ecosystem is composed of several master nodes and child nodes, so the ecosystem is not limited to the applications in the apparel industry, but also applicable to the fields of warehousing, logistics, electronic license plate and asset management. Here we only take a simple example to explain the application in the apparel industry.

## **Production**

In the early stage of production, the production target is made according to the production plan and related needs. In the first phase of production, a unique RFID will be generated for each product. The status and related information of this ID will be recorded at each child node in the production, also at each subsequent master node and corresponding child node. The contents of the status and



---

information are negotiated by the master nodes. Each node is rewarded according to the contribution in the form of Waltoncoin. The number of awards can be determined based on the workload or the work quality of the corresponding node or the specific situation of the application.

## **Warehousing**

This node mainly refers to the storage after production, containing three sections: warehouse-in inspection, storage location and warehouse-out inspection. Each section has a corresponding reader to record the corresponding information and form a corresponding block in this master node of warehousing to connect with the block generated in the production.

## **Logistics**

This node is similar to the previous one, it mainly records the status and information in the process of transportation and forms the corresponding block data.

## **Stores**

This node can be a store, or many stores. Each store is regarded as a master node to record the status and information of the product as well as customer information and preferences. This node can give a customer the corresponding reward according to the customer's consumption situation in the form of Waltoncoins and include the customer into the master node according to the amount of Waltoncoins held by the customer and give the customer the appropriate permissions. The customer can check all product information and all billing data, but needs to pay certain Waltoncoins. The customer can also use Waltoncoins to purchase the corresponding products.

---

## **Main Characteristics of the System**

- 1. Each child node is equipped with a reader and connected to the master node;**
- 2. The master node is connected to the Internet, it is online in real time;**
- 3. Each master node manages the bills. The data between the master nodes are transparent;**
- 4. After the nodes reach a consensus, the number of various master nodes can continue to increase;**
- 5. According to the amount of Waltoncoins held by the purchaser, the purchaser can be included in the node after the nodes reach a consensus and vote for the rights of accounting and checking to be authorized to the purchaser;**
- 6. Checking bills and accounting will consume Waltoncoins (as handling fees);**
- 7. The purchaser can also directly pay Waltoncoins to purchase clothing.**

## **Main Advantages of the System**

- 1. Can really achieve tracing the source;**
- 2. Can really achieve the purpose of unforgeability;**
- 3. Can achieve decentralization without the concern of trust;**
- 4. Can reduce labor costs.**

---

## **Multi-User Consensus Security Mechanism**

- 1. The mechanism generates a set of random numbers by the master node;**
- 2. Divides this set of random numbers into N parts (N is an integer and greater than  $2/3$  of the number of all users);**
- 3. Encrypts N parts of random numbers with the public key of N users separately;**
- 4. All users decrypt this set of random numbers with their own private key;**
- 5. When the master node receives all the correct data, it is considered that this accounting or modification is valid.**

### **2.4 Application Scenarios: Waltonchain Project's System Solutions for the Apparel Industry**

With the rapid development and integration of the Internet of things, mobile Internet, cloud computing and other information technology, the intelligent management of information has become a key factor in the rapid growth and improvement of enterprises. As a core technology of Internet of things, the RFID is widely used in the intelligent warehousing and logistics management, and the apparel industry is one of the most promising fields for applying RFID technology.

Due to the apparel industry's particularity and complexity, thorny problems exist in various links in the value chain of traditional apparel industry, including logistics, warehousing, sorting business, store sales and inventory. For example, complex product specifications with various size, styles and rapid changes; frequent unpacking and messy piles; slow turnover in warehousing management, production, inventory and distribution; great reliance on staff experience for



---

searching needed commodity; big difference between stock-in and stock-out; difficulty in taking inventory; heavy workload; FCL and one-piece warehousing modes coexist; impossibility of tracing the clothing sources. Therefore, pasting, embedding or implanting RFID tags on the tag of each piece of clothing can increase supply chain management transparency and inventory turnover, reduce the loss due to out of stock, enhance the store experience and increase consumer satisfaction, while conducting real-time intelligent data analysis and collecting data to guide the garment enterprises to adjust their product design, production and inventory in a timely manner.

#### **2.4.1 Analysis on the Dilemma of the Traditional Apparel**

##### **Manufacturing**

The 13th Five-Year Plan for China's apparel industry clearly points out that we need to speed up the construction of flexible supply chain management system and intelligent warehousing, logistics and distribution system with RFID as the core, to improve the system functions and the adaptability of business process reengineering, to achieve a seamless connection of various management systems, to promote big data, "Internet +" and other technology applications, to improve the intelligent level of managerial decision-making, to vigorously promote the mass customization technology and its manufacturing model, to promote the transformation from garment manufacturing to garment services and to promote the deep integration of manufacturing and services and to enhance the application level comprehensively.

In recent years, the overall retail sales of the apparel industry grew steadily, the total domestic sales volume has been increasing, online channels expand rapidly, the growth rate of offline sales going down, the domestic market loses

---

momentum and export faces major difficulties. The apparel industry needs to speed up structural adjustment, transformation and upgrading.

Facing the “new normal” of slow growth and steady total volume the traditional manufacturing companies are impacted by, the clothing manufacturing section is compelled to upgrade in order to improve the competitiveness of garment enterprises. The apparel manufacturing is transforming from the mode of large quantities, less varieties and long cycle to the mode of small quantities, more varieties, short delivery and customization.

#### 2.4.2 Smart Manufacturing Solution for the Apparel Industry

The traditional apparel industry is a labor-intensive industry characterized by overall multi-variety, rapid changes and relatively low level of informatization and intelligentization. The production process is shown in Figure 2.9.

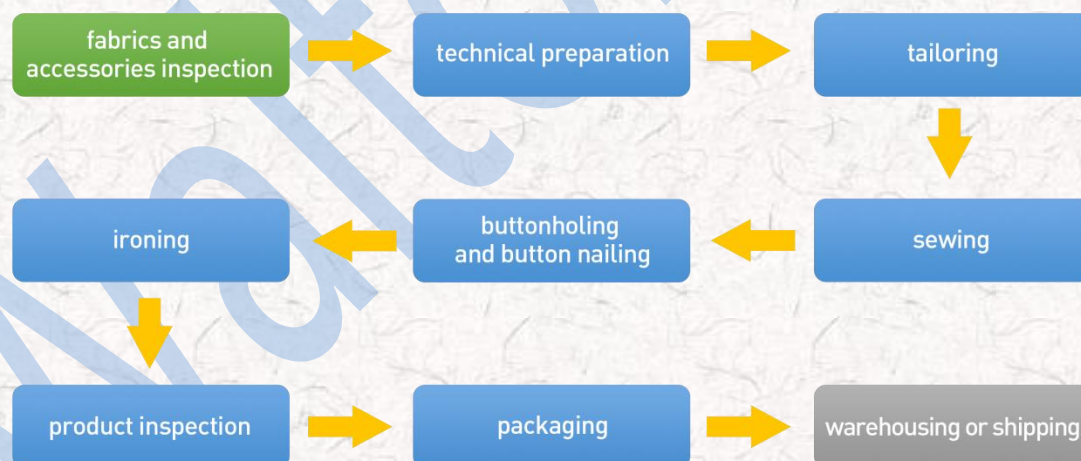

Figure 2.9: Traditional garment production and processing flow diagram

Based on the above characteristics, the future intelligent garment factory is a Customer to Manufactory (C2M) customization platform; the consumer demand directly drives the effective supply of the factory, as shown in Figure 2.10.

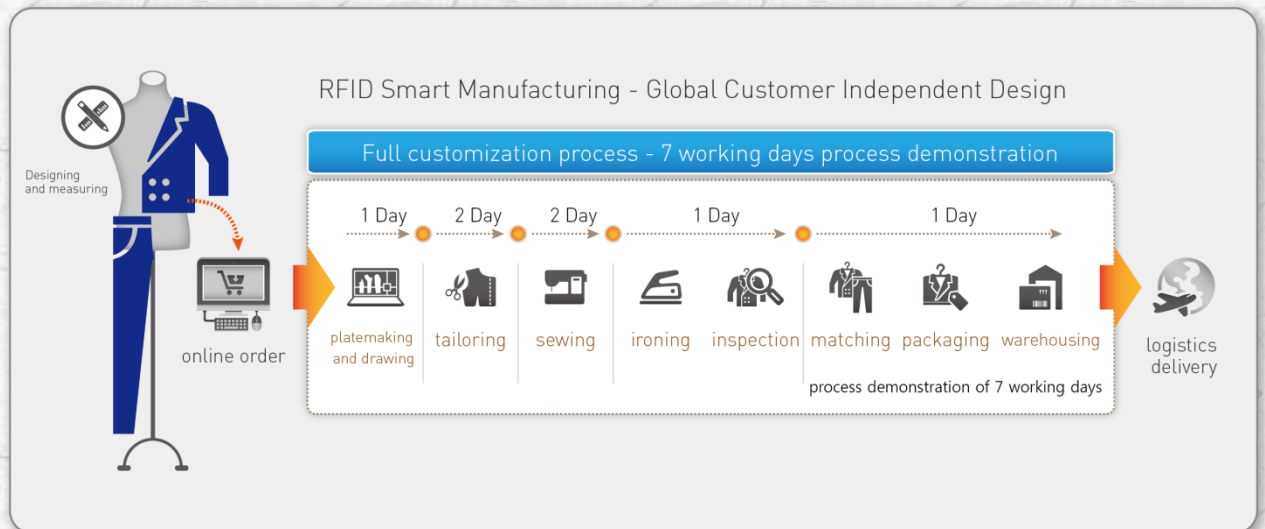

Figure 2.10: An example of an intelligent garment factory

So, with a data-driven production process, online design, order-taking, customization data transmission are all digitalized, forming an operating system of demand data collection, demand data to production data transformation, smart research and development and design, smart production scheduling, smart automatic typography, data-driven value chain collaboration, data-driven production, data-driven quality assurance, data-driven logistics and distribution, data-driven customer service and fully digital customer service. As shown in Figure 2.11, the RFID-based smart production line greatly improves the efficiency of industrialization, shortens the production cycle to 7 working days while the personalized manufacturing costs are only 10% higher than those of the mass manufacturing, truly realizing the mass customization of personalized products. Everyone will be able to afford customized clothing.



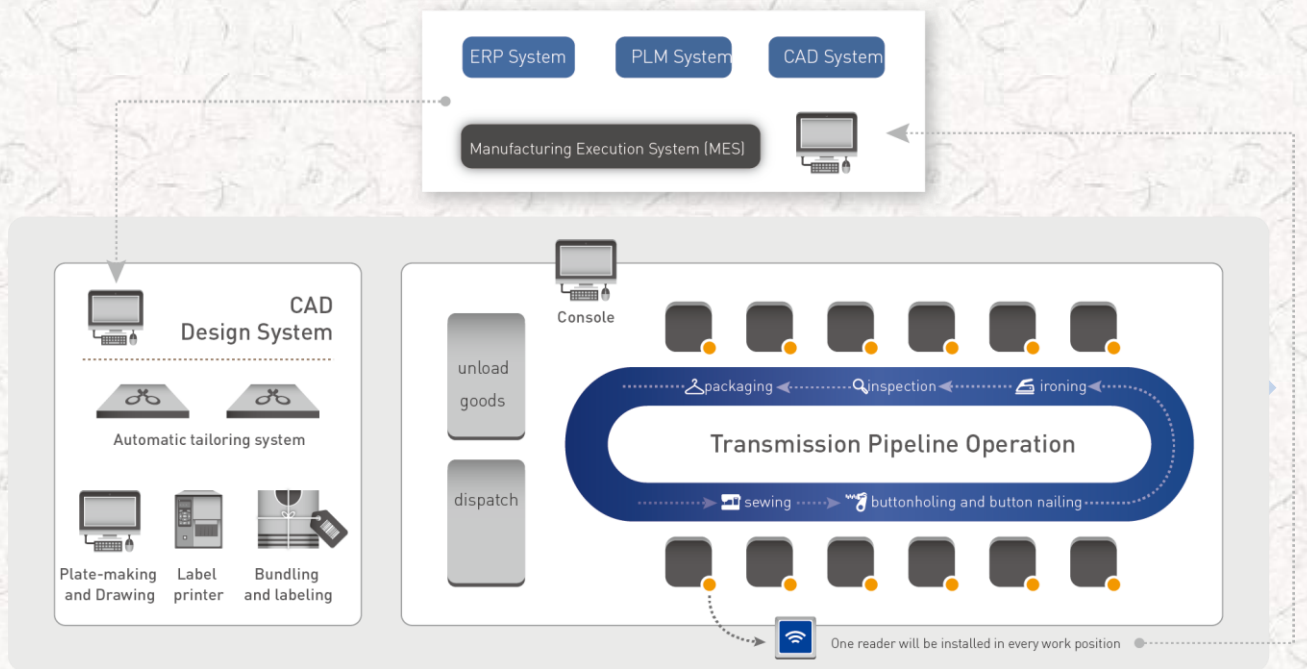

Figure 2.11: RFID-based intelligent production line structure diagram

### 2.4.3 Smart Logistics & Warehousing Solution for the Apparel Industry

The apparel industry logistics has the following characteristics: diverse management objects, various brands, diverse types, many SKUs (Stock Keeping Unit); diverse sales models, complex logistics channels, generally including “online + offline” model and “directly managed stores + franchises + agents” model; strong seasonality, rapid logistics response required, different products for spring, summer, autumn and winter, short product life cycle, usually 2 to 3 months; difficult inventory control, long production and marketing chain, many sections, multi-level segmented inventory, generally including factory inventory, headquarters inventory and channel inventory; multi-stage network for logistics and distribution, including Headquarters logistics distribution, branch logistics distribution and agent logistics distribution.

---

The apparel logistics network is a three-tier separated network where a variety of logistics channels coexist, usually with a model of raw materials and accessories distribution + finished product distribution + terminal distribution by factories + headquarters + subsidiaries . The types of business operation include wholesale, retail, e-commerce and group purchase. The products include different logistics channels of various brands. The logistics problems are as follows: long logistics channel, the overall logistics channel includes factory warehouse — headquarters warehouse — subsidiary warehouse — store or factory warehouse — headquarters warehouse — agent/dealer warehouse; high supply chain inventory, low storage efficiency, too many inventory points, the storage cycle is usually 180 days, with backward warehousing management methods and means; multi-stage transportation, complex management, the transportation modes include container shipping by the factory, distribution and transportation by the headquarters, distribution and transportation by the branch/agent, etc. Based on the above characteristics of the logistics, we put forward a smart storage solution shown in Figure 2.12.

## Intelligent Implementation Plan



Figure 2.12: The intelligent warehousing solution

### 2.4.4 Smart Store Solution for the Apparel Industry

Figure 2.13 shows the functional scenes of a smart store. At the point of arrival, before the goods go into the store, the staff shall use RFID PDA to batch read the data on the clothing tags, match with the receipt, check the quantities and models of goods and correct errors manually.





Figure 2.13: Smart store functional scene diagram

Specific functions are as follows.

**Quick stocktaking function:** the staff uses the PDA to collect clothing label information and transmit to the background server for data comparison, the difference is displayed on the PDA in real time for manual check and the stocktaking information on the back-end server is updated through the PDA.

**Quick find function:** the staff enters the label information of the product to be found into the RFID PDA to turn on the search mode and quickly locate the specific location of the product according to the beep produced based on the strength of the signal.

**Smart hanger function:** when the customer picks up the clothes on the smart hanger, the smart hanger automatically identifies the clothing label in the hands of the customer, the touch screen displays all the information of the clothes in a timely manner and inputs the data into the background server at the same time;

---

the analyzing software automatically counts the data and generates statistical reports of each period for managers to view.

**Smart fitting room function:** when the customer picks up the clothes and walks into the fitting room, the smart fitting room automatically identifies the clothing label in the hands of the customer, the touch screen displays all the information of the clothes in a timely manner and inputs the data into the background server at the same time; the analyzing software automatically counts the data and generates statistical reports of each period (hour/month) for managers to view and estimate the production plan and popular designs according to the fitting rate.

**Quick check-out function:** with RFID, the target information can be identified automatically, the receiver can read multiple tags at once within its effective working range to achieve the simultaneous identification of multiple products, thus speeding up the check-out process and improving customer satisfaction.

Figure 2.14 shows a smart fitting room. Icons 1 & 2: the staff reads the clothes label and transmits the data to the service desk; icon 3: the service desk pushes information to the match system for selection; icons 4 & 5: the customer chooses the product to try and informs the help desk; icons 6 & 7: the staff uses the PDA to quickly find the product and sends to the customer.



Figure 2.14: The smart dressing room functional scene diagram

With RFID system solution developed by the Waltonchain team based on the blockchain technology, the end customers can use bar codes or RFID tags to identify all system information of every clothing product, including accessories, fabric, production process, logistics and distribution and store it in the blockchain system. For brands in the clothing business, the functions of tamper-resistance, reliability, anti-counterfeiting and traceability can be achieved. Once the companies find any problems, they can effectively control and recall products according to the source tracing and protect the legitimate rights and interests of consumers fundamentally. Consumers can rest assured to buy their favorite products; the system enhances shopping experience and improves consumer satisfaction.



---

## **Part 3 Future — Value Internet of Things Will Change the World**

### **3.1 The Stage Planning of the Waltonchain Project**

As mentioned above, the realization of Value Internet of Things will create a new ecology of the existing business, which is based on the organic integration of the blockchain and the Internet of Things. The combination of RFID technology and Waltonchain will extend the blockchain technology from the Internet to the Internet of Things and create an authentic, trustworthy, traceable and fully transparent business ecosystem with fully-shared data. The Waltonchain team carefully planned four growth stages starting from building the underlying foundation, gradually extending to a retail and logistics network and finally integrating product manufacturers. Step by step, in the forthcoming future Waltonchain will achieve the full coverage of commercial ecology.

During the Waltonchain Project 1.0 stage, the team has developed a clothing system integration solution based on RFID technology, which has been applied in several pilots such as Tries, SMEN and Kaltendin. Now we are ready for large-scale promotion and need to lay a solid customer base. We have started to develop the RFID beacon chip with independent intellectual property rights, which innovatively integrates an asymmetric encryption algorithm based on the traditional RFID chip and expected to achieve the perfect combination of Internet of Things and blockchain. Combined with the integrated solution for the apparel industry based on RFID technology, it is expected to solve the problems of the traditional apparel industry including warehousing, logistics, stores and aftermarket, and in the meantime, to consolidate the basic platform of Waltoncoin. The application

---

scenarios of the project's 1.0 stage will build a Golden demonstration template for the rapid promotion of Waltonchain's applications.

During the Waltonchain Project 2.0 stage, the independently developed RFID beacon chip will be in full mass production and can be used in B2C retail industry and logistics industry. Development of a smart credit system will be completed, fully integrating payment, gifting, same currency transactions, different currency transactions, etc. through Waltonchain's flexible and powerful token creation and transaction functions. Availability of complete information, including merchandise procurement, distribution, stock-in, stock-out, stores, shelves inventory, sales, customer purchase, customer evaluation and after-sales service, on the chain will be achieved through an optimized blockchain data structure design. Customers will be provided with such functions as payment, integral management and trading, product evaluation and query, tracing and obtaining evidence for a quality problem, etc. Merchants will be provided with automatic management of business operations, information mining during procurement, sales, after-sales and information on real-time market trends. Thus a win-win-win situation will be achieved for all three parties: customers, merchants and Waltonchain. By virtue of a blockchain data structure matching multi-scenarios, the logistics industry will be able to achieve availability of full path logistics information on the chain, covering the complete business process including pricing, packing, sorting & distribution, warehouse management, sorting & sending, home delivery, customer receipt and customer feedback. Based on characteristics of RFID such as being tamper-resistant, open, traceable etc., the stage is aimed at building a safe and reliable point-to-point logistics information channel for customers and provision of a business automatic management information platform for logistics companies to avoid thorny problems, such as lost, delayed and wrong orders on a systematic basis.



---

During the Waltonchain Project 3.0 stage, the technology will be applied to all product manufacturers to achieve smart packaging and traceable customization. The universal data structure used in describing the production cycle will be effectively written to the blockchain. The customized data structure will be designed for different products. With RFID identity verification, the authenticity and reliability of the information added to the chain is guaranteed. The whole process will be covered, including raw material purchasing, production operations, assembly operations, product packaging and product inventory management. Raw material sources and production quality can be verified and the quality problem source can be tracked by taking the advantages of openness and traceability of blockchain. The possibility of counterfeit can be eliminated and the information barrier can be removed to ensure the consumers' interests fundamentally. At the same time, low-cost data information solutions can be provided to product manufacturers by means of standardized and reliable recording of manufacturing operation information via blockchain so as to achieve smart management for manufacturers.

During the Waltonchain Project 4.0 stage, with upgrading and iteration of the asset information acquisition hardware and improvement of the blockchain data structure, all the assets will be registered on Waltonchain in the future so as to solve the problems of asset ownership, item traceability and transaction certificate. By then, Waltonchain and Waltoncoin will be widely used in the physical world, fundamentally changing the way of life and production worldwide — Waltonchain project will bring a more convenient, intelligent and trustworthy world to everybody, and at the same time, give handsome returns to investors of Waltonchain.

In accordance with the four stages of the project, the project team will develop a variety of information collection-related chips, including dual-band RFID chips, biometric chips and various sensor chips. The team will not only provide



secure interfaces for all physical assets to be on the chain, but also provide secure interfaces for human beings, all kinds of animals, creatures to be on the chain, to realize safe and reliable networking, aggregation, digitization of all things, completely change people's way of life and bring more convenience to human life. The application scope of Waltonchain will be gradually extended to every life scene, as shown in Figure 3.1.



Figure 3.1: The scope of application of Waltonchain

## 3.2 The Investment Value of the Waltonchain Project

1) Innovation mode: the Waltonchain Project intends to develop an RFID beacon chip with independent intellectual property rights, which is expected to achieve the perfect combination of Internet of Things and blockchain. The researched and developed chips will bind Waltoncoins to create the intelligent

---

ecosphere of application of Internet of Things based on Waltonchain. During the course of expanding blockchain technology to the Internet of Things, Waltonchain will definitely become the leader of the changing times;

2) Market space: with a trillion-level potential market, Waltonchain has possessed the applicable program able to be quickly implemented in the total value chains in the clothing industry, including the production, storage, logistics, stores and other full circulation areas. Years of working experience and customer resources accumulated by the team members in the clothing industry and electronics industry will provide favorable conditions for the implementation of the project. In the foreseeable future, it is also expected to be used in many fields like electronic license plate and asset management, etc.;

3) High-frequency application: Waltonchain is loaded on the RFID hardware system to break through the bottleneck in commercial application of blockchain, namely, the problem of how real assets off the chain are chained quickly, efficiently and safely. Therefore, Waltonchain is a commercial ecological chain with a low threshold and high-frequency application where the range of application scenarios will be wide and popularity very high;

4) Ecological network: Waltonchain will establish the ecological chain of Internet of Things with its own content. As the only token of fundamental chain for this ecological network, Waltoncoin will be circulated in a wide range of business areas, so it has multiple significant functions including value storage, value circulation, credit trading, commodity payment medium etc. With the increasing popularity of RFID beacons and the expanding demand for the network, the demand for Waltoncoin will be expanding correspondingly, so Waltonchain's early investors will get substantial returns with the development and growth of Waltonchain.

---

5) Profit mechanism: Waltoncoins issued by ICO are the tokens of Waltonchain's parent chain. With the development of the parent chain and its subchains, according to the protocol mechanism of Waltonchain system, Waltoncoin, as the mother token, will receive dividends from all levels of the system in order to nurture the blockchain system of Waltonchain, making it more robust and safer and bringing about a harmonious virtuous circulation.



---

## Part 4 Project Foundation

The project foundation was established in 2017, known as the Waltonchain Foundation. The Foundation is committed to the development of the Waltonchain project, the promotion and implementation of RFID applications and the promotion of early development of decentralized applications. 20% of the initial WTCs will be used for some industry applications and start-up projects, such as financial services, supply chain, Internet of things, blockchain, etc., including project strategic planning, project support, project promotion and token exchange. The Foundation will select the decentralized applications developed on Waltonchain and provide rewards based on the actual number of users on the applications.

The overall structure of the foundation is shown in Figure 4.1. The Decision-Making Committee shall have three subdepartments, including Technology Development Committee, Finance and Personnel Management Committee and Project Operations Committee, which shall be responsible for the development, implementation and supervision of technology development strategies; the development, implementation and supervision of the financial system; the decision-making and implementation of the overall project operation and marketing, respectively. The members of the Decision-Making Committee change every four years. The members generally include two representatives recommended by each subcommittee: a project investor representative, a community representative and a member of the Waltonchain team. The members of the subcommittees change every four years. The members are generally prominent people from related industries.



Figure 4.1: The overall structure of the Waltonchain Foundation

The Foundation promotes a transparent and efficient operational philosophy to promote the healthy development of the Waltonchain ecosystem. The governance structure mainly focuses on the effectiveness, sustainability and financial security of project management. The foundation's mission is to promote the development of blockchain technology from the Internet to the Internet of things and to invest the funds raised by ICO in the following directions:

1. Planning to develop the RFID beacon chips with independent intellectual property rights which use an asymmetric encryption algorithm with independent intellectual property rights and can achieve the perfect combination of the Internet of Things and the blockchain;
2. Establishing a smart credit system fully integrating payment, gifting, same currency transactions, different currency transactions, etc. through WTC's flexible and powerful token creation and transaction functions;
3. Availability of complete information, including merchandise procurement, distribution, stock-in, stock-out, stores, shelves inventory, sales, customer purchase, customer evaluation and after-sales service, on the chain will be

---

achieved through an optimized blockchain data structure design, which ends up with a win-win-win situation for customers, merchants and Waltonchain;

4. By virtue of a blockchain data structure matching multi-scenes, it is aimed at building a safe and reliable point-to-point logistics information channel for customers and providing business automatic management information platform for logistics companies to avoid thorny problems such as lost, delayed and wrong orders on a systematic basis.
5. Applying to the product manufacturers and achieving smart packaging and traceable product customization.

The projects above will provide convenient data query and traceability, analysis and processing and transaction management interfaces to customers, provide smart management interface to businesses. With the further application of machine learning and artificial intelligence, an intelligent ecosystem of the complete supply chain will ultimately be created, including a production, logistics, stores, sales and after-sales service.



---

## Part 5 Team Introduction

### 第五部分 团队简介

#### 5.1 Initiators

**Xu Fangcheng (initiator in China):** Chinese, majored in Business Management, former Director for Supply Chain Management of Septwolves Group Ltd., has rich practical experience in supply chain management and purchasing process management. Currently, he is the Director of Shenzhen Silicon, the Director of Xiamen Silicon and the Board Chairman of Quanzhou Silicon. He is also one of our Angel investors.



**Do Sang Hyuk (initiator in Korea):** Korean, Vice Chairman of the China-Korea Cultural Exchange Development Committee, Chairman of Korea NC Technology Co., Ltd., former Director of the South Korea Electronic News Media Bureau, Director of ET News, Former Director of Korean Standards Association, Chairman of Small and Medium-Sized Enterprise Committee in Seongnam, South Korea, Representative of Jiangsu Mingxing Liangcheng Environmental Protection Co., Ltd., China.



---

## 5.2 Senior Advisors

**Kim Suk Ki (Internet of Things):** Korean, one of the key persons in South Korean electronics industry, Doctor of Engineering (graduated from the University of Minnesota), Professor of Korea University, previously worked at Bell Labs and Honeywell USA, served as a Vice President of Samsung Electronics, senior expert in integrated circuit design, IEEE Senior Member, Vice President of the Korean Institute of Electrical Engineers, Chairman of the Korea Semiconductor Industry Association. He has published more than 250 academic papers and possesses more than 60 patents.



**Zhu Yanping (blockchain):** Taiwanese, Doctor of Engineering (graduated from National Cheng Kung University), Chairman of the Cloud Computing & IoT Association in Taiwan, Director of Information Management Department of National Chung Hsing University. He has won the Taiwan Ministry of Education Youth Invention Award and Taiwan Top Ten Information Talent Award. Has deeply studied blockchain applications over the years and led a blockchain technology team to develop systems for health big data and agricultural traceability projects.





---

## 5.3 Chief Experts

**Mo Bing (Internet of Things):** Chinese, PhD in Engineering, post-doctor, his mentor is Professor Kim Suk Ki, a well-known Korean expert in the field of integrated circuits. He is a research professor of Korea University, distinguished researcher of Sun Yat-Sen University, expert in Internet of Things, expert in integrated circuits, senior member of the Chinese Society of Micro-Nano Technology, IEEE member. He is a high-level talent of Fuzhou city under the Bringing in Talents campaign. Evaluation expert of science and technology programs at Fujian Province Science and Technology Department, evaluation expert of science and technology programs at Jiangxi Province Science and Technology Department, Director of Xiamen City Integrated Circuit Association, an expert team member at Tape-out Subsidies Review Committee. At present, he has presided over 10 scientific research projects, published more than 20 articles and applied for 18 invention patents. In 2013, he began to contact Bitcoin, is one of the earliest users of Bitcoin and Korbit. Since 2015, he mainly engaged in research of integrated circuits and blockchain. Two commercial chips have been successfully developed under his guidance.





---

**Wei Songjie (blockchain):** Chinese, Doctor of Engineering (graduated from the University of Delaware), Associate Professor of Nanjing University of Science and Technology, Core Member and Master Supervisor of Network Space Security Engineering Research Institute, blockchain technology expert in the field of computer network protocol and application, network and information security. Has published more than 20 papers and applied for 7 invention patents. Previously worked at Google, Qualcomm, Bloomberg and many other high-tech companies in the United States, served as R&D engineer and technical expert; has a wealth of experience in computer system design, product development and project management.



## 5.4 Team Members

**Shan Liang:** Chinese, graduated from KOREATECH (Korea University of Technology and Education) Mechanical Engineering Department, Venture Capital PhD, GM of Waltonchain Technology Co., Ltd. (Korea), Director of Korea Sungkyun Technology Co., Ltd., Chinese Market Manager of the heating component manufacturer NHTECH, a subsidiary of Samsung SDI, economic group leader of the Friendship Association of Chinese Doctoral Students in Korea, one of the earliest users of Korbit, senior digital money player.



---

**Chen Zhangrong: Chinese, graduated in Business Management, received a BBA degree in Armstrong University in the United States, President of TIANYU INTERNATIONAL GROUP LIMITED, leader of Chinese clothing & accessories industry, China's well-known business mentor, guest of the CCTV2 Win in China show in 2008. Researcher in the field of thinking training for "Practical Business Intelligence" e-commerce and "MONEY&YOU" course, expert on success for "Profit Model" course. Began to contact Bitcoin in 2013 with a strong interest and in-depth study of digital money and decentralized management thinking. Has a wealth of practical experience in the business management, market research, channel construction, business cooperation and business model.**



**Lin Herui: Chinese, Dean of Xiamen Zhongchuan Internet of Things Industry Research Institute, Chairman of Xiamen Citylink Technology Co., Ltd., Chairman of Xiamen IOT. He successively served as Nokia R&D Manager and Product Manager, Microsoft Hardware Department Supply Chain Director. In 2014, started to set up a number of IoT enterprises and laid out the industrial chain of the Internet of Things. The products and services developed under his guidance are very popular. Assisted the government in carrying out industrial and policy research and participated in planning of multiple government projects of smart cities, IoT towns and project reviews.**





---

**Ma Xingyi: Chinese, China Scholarship Council (CSC) special student, Doctor of Engineering of Korea University, Research Professor of Fusion Chemical Systems Institute of Korea University, Korea Sungkyun Technology Co., Ltd. CEO, Member of Korea Industry Association, Associate Member of the Royal Society of Chemistry, has published his research results in the world's top journal Nature Communications and participated in the preparation of a series of teaching materials for Internet of Things engineering titled "Introduction to the Internet of Things". His current research direction covers cross-disciplines that combine blockchain technology with intelligent medical technology.**



**Zhao Haiming: Chinese, Doctor of Chemical Conductive Polymer of Sungkyunkwan University, core member of Korea BK21th conductive polymer project, researcher of Korea Gyeonggi Institute of Sensor, researcher of Korea ECOTech Co., Ltd., Vice President of the Chinese Chamber of Commerce, Director of Korea Sungkyun Technology Co., Ltd. He has been engaged in transfer of semiconductor, sensor and other technologies in South Korea. He is an early participant of the digital currency market.**





---

**Liu Cai: Chinese, Master of Engineering, has 12 years of experience in design and verification of VLSI and a wealth of practical project experience in RFID chip design process, SOC chip architecture, digital-analog hybrid circuit design, including algorithm design, RTL design, simulation verification, FPGA prototype verification, DC synthesis, back-end PR, package testing, etc. Has led a team to complete the development of a variety of navigation and positioning baseband chips and communication baseband chips, finished a series of AES, DES and other encryption module designs, won the first prize of GNSS and LBS Association of China for scientific and technological progress. Finally, he is an expert in the consensus mechanism principle of blockchain and the related asymmetric encryption algorithm.**



**Yang Feng: Chinese, Master of Engineering, worked at ZTE. Artificial intelligence expert, integrated circuit expert. Has 12 years of experience in VLSI research and development, architecture design and verification and 5 years of research experience in artificial intelligence and the genetic algorithm. Has won the Shenzhen Science and Technology Innovation Award. Has done an in-depth research on the principle and realization of the RFID technology, the underlying infrastructure of blockchain, smart contracts and the consensus mechanism algorithm.**



---

**Guo Jianping: Chinese, Doctor of Engineering**  
(graduated from the Chinese University of Hong Kong),  
Associate Professor of the Hundred Talents Program of Sun  
Yat-sen University, academic advisor of master's degree  
students, IEEE senior member, integrated circuit expert. Has  
published more than 40 international journal & conference  
papers in the field of IC design and applied for 16 patents in  
China.



**Huang Ruimin: Chinese, Doctor of Engineering**  
(graduated from the University of Freiburg, Germany),  
academic advisor of master's degree students, lecturer of  
the Department of Electronics of Huaqiao University,  
integrated circuit expert. Mainly explores digital signal  
processing circuit and system implementation and works on  
digital signal processing technology long-term research and  
development.



**Guo Rongxin, Chinese, Master of Engineering, Deputy  
Director of the Communication Technology Research Center  
of Huaqiao University. Has more than 10 years of experience  
in design and development of hardware and software for  
embedded systems, works on the long-term research and  
development of RFID and blockchain technology in the field  
of Internet of Things.**





---

**Li Shuai: Chinese, Master of Engineering, his research focus lies in network security and blockchain access authentication technology. The project on blockchain distributed authentication completed under his direction won the final first prize of the “2016 National Cryptography Technology Competition”.**



**Huang Hongtai: Chinese, Bachelor of Engineering, has five years of experience in WEB front and back-end development, works on the long-term development of Internet of Things platforms and educational information platforms. Began to contact Bitcoin in 2011 and become an early graphics card mining participant. Has a strong interest in virtual currency and blockchain technology.**



**Dai Minhua: Chinese, graduated in Business Management, received a BBA degree from Armstrong University, senior financial expert, served as Vice President and CFO of Tanyu International Group Co., Ltd. Has 13 years of financial work experience, has a wealth of experience in developing and implementing enterprise strategy and business plans, as well as achieving business management objectives and development goals.**





---

**Liu Dongxin:** Chinese, received an MBA from China Europe International Business School, Visiting Scholar of Kellogg School of Management at Northwestern University, strategic management consulting expert, investment and financing expert. His current research interest lies in the impact of the blockchain technology on the financial sector.



## 5.5 Angel Investors

**Song Guoping:** Doctor of Medicine, President of Chinese Chamber of Commerce in Korea, Director of Beijing Overseas Friendship Association, representative of Ping An International Co., Ltd., representative of Oriental Xu Fu Anti-Aging Center, Representative of Sumei Beauty Shaping.

**Qiu Jun:** Chairman of Shenzhen Hongtao Fund Management Co., Ltd., Vice President of Shenzhen Shanwei Chamber of Commerce. Has 20 years of capital market investment experience, experienced many magnificent market changes, achieved a number of classic investment cases, including SMIC, China Merchants Securities and Guangdong Danxia Biopharm, etc. Guangdong Danxia Biopharm was acknowledged as one of the top ten successful cases of biopharmaceutical investment in 2016.

**Yan Xiaoqian:** Chairman of Kaltendin Clothing Co., Ltd., Executive Vice President of Shenzhen Shanwei Chamber of Commerce.

**Lin Jingwei:** Director of Guangzhou Jiuying Investment Management Co., Ltd., received a master's degree in Senior Financial Accounting and an EMBA degree from Sun Yat-sen University; has 27 years of work experience at large state-owned

---

enterprises in China and abroad and more than 15 years of work experience as the Secretary of the Board of Directors, Chief Financial Officer and Deputy General Manager of large Chinese state-owned enterprises, has been in charge of enterprise listing, capital operation, investment, financing and financial management for a long time. Has a wealth of experience in capital operation and financial management. Has the qualifications for Secretary of the Board of Directors or Independent Director of listed companies.

**He Honglian:** Director of Waltonchain Investment Division, Certified Public Accountant, received an MBA degree from Xiamen University. Previously served as the Investment Center Manager of Meiya Pico, currently leads the Waltonchain investment team to research and plan investment in the field of Internet of Things and integrated circuits.

## **5.6 Consultant Team**

**I Jong Gil:** representative of BSM, Chairman of the Korea Carbon Convergence Committee and Active Carbon Committee.

**Go Sang Tae:** Deputy Director of Editorial Board of Korea Electronic News Agency, Director of the New Media and New Industry Bureau of KI news.

**Liu Xiaowei:** Professor of Harbin Institute of Technology, academic advisor of doctoral students, chief expert of the Program 973. Member of the expert group on assembly of micro- and nanotechnology devices, member of the expert group on assembly of a wide range of military electronic components, Deputy Director of the Force Sensing Specialized Committee of the Sensing Technology Division of the Chinese Institute of Electronics, Deputy Secretary-General of Chinese Northeast Micro-Electro-Mechanical System Technology Consortium, editorial board member of the book titled "Sensor Technology", Heilongjiang Province CPPCC member.



---

**Su Yan: Professor of Nanjing University of Science and Technology, academic advisor of doctoral students, Vice President of the Naval Instrument and Control Academic Board under the Chinese Society of Naval Architects and Marine Engineers, Vice Chairman of the China Instrument and Control Society Naval Instrument and Control Branch, Executive Director of the MEMS & NEMS Society of China, CIS, Executive director of Jiangsu Institute of Instrumentation, expert on components.**

**Zhang Yan: Doctor of Engineering, Professor, academic advisor of doctoral students. Currently serves as Associate Dean of Harbin Institute of Technology (Shenzhen) School of Electronics. Expert in the areas of digital integrated circuit design and embedded systems.**

**Ma Pingping: received a Master of Economics from Xiamen University, serves as general manager at Septwolves Venture Capital Limited.**

**Peng Xiande: Senior Lawyer, Guangdong Wenpin Law Firm partner, expert in company law, investment and financing legal affairs with more than twenty years of judicial practical experience.**

**Bo Ke: graduated from Henan University of Economics and Law, Senior Lawyer of Guangdong Ruiting Law Firm, China registered lawyer, member of the All China Lawyers Association, member of Shenzhen Lawyers Association, has more than 20 years of experience in legal services.**

**Xiao Guangjian: Senior Accountant, Tax Accountant, Senior Economist, Secretary-General of Shenzhen Sanming Chamber of Commerce, Shenzhen Lianjie Accounting Firm partner, Senior Financial Expert, has more than ten years of experience in financial consultancy of listed companies.**

**Li Xiong: founder of the FINANCIAL CHAIN ([www.chainfor.com](http://www.chainfor.com)), Internet finance serial entrepreneur, a veteran in blockchain industry. Has 7 years of**



---

product design, marketing operations, brand public relations and team management experience. Embarked on entrepreneurship in blockchain industry since 2013 and founded sosobtc, ICO365, icolive blockchain service platforms. Has a sophisticated understanding of blockchain. Currently, focuses on research of blockchain and cryptocurrency ecosystems and their application.

Wattonchain

---

## Part 6 References

1. **A. Tapscott, D. Tapscott, How blockchain is changing finance, Harvard Business Review, 2017.**
2. **T. Stein, Supply chain with blockchain — showcase RFID, Faizod, 2017**
3. **S. Nakamoto, Bitcoin: A peer-to-peer electronic cash system, Bitcoin.org, 2009.**
4. **R. Hackett, The financial tech revolution will be tokenized, Fortune, 2017.**
5. **Swedberg, Blockchain secures document authenticity with smartrac's dLoc solution, RFID Journal, 2016.**
6. **Bayer, S. Haber, W.S. Stornetta, Improving the efficiency and reliability of digital time-stamping, Sequences II: Methods in Communication, Security and Computer Science, 1993.**
7. **Legay, M. Bozga, Formal modeling and analysis of timed systems, Springer International Publishing AG, 2014.**
8. **Back, Hashcash — a denial of service counter-measure, Hashcash.org, 2002.**
9. **Dickson, Blockchain has the potential to revolutionize the supply chain, Aol Tech, 2016.**
10. **KCDSA Task Force Team, The Korean certificate-based digital signature algorithm, IEEE Standard Specifications for Public-Key Cryptography, 1998.**
11. **J. Donaldson, Mojix brings transformational RFID, big data analytics and blockchain technology to NRF Retail's Big Show, Mojix.com, 2017.**
12. **R. T. Clemen, Incentive contracts and strictly proper scoring rules. Test, 2002.**

- 
13. J.-Y. Jaffray, E. Karni, Elicitation of subjective probabilities when the initial endowment is unobservable, *Journal of Risk and Uncertainty*, 1999.
  14. Blockchain Luxembourg S.A., <https://blockchain.info>.
  15. J. Gong, *Blockchain society — decoding global blockchain application and investment cases*, CITIC Press Group, 2016.
  16. Johnston et al., *The general theory of decentralized applications*, Dapps, 2015.
  17. P. Sztorc, *Peer-to-peer oracle system and prediction marketplace*, 2015.
  18. R. Hanson, Logarithmic market scoring rules for modular combinatorial information aggregation, *Journal of Prediction Markets*, 2002.
  19. Pan Wei Di, *analysis of the status quo and future of virtual currency development in China*, Enterprise Herald newspaper, 2016.
  20. Li Wei, *Studies on Virtual Currency Legal Issues*, Foreign Economic and Trade University Doctoral Dissertation, 2016.