



NPER

WHITE PAPER

Global Blockchain Intellectual Property Network

"NPER" is a project to overcome the monopolistic industrial structure and stereotypes in the copyright industry. We will protect the creator's proper right and present a new paradigm to everyone which makes them possible to own and distribute the royalties and added-value that the only minority used to monopolize.

This White Paper states the current views of NPER Labs OU, concerning the NPER Platform and related matters. NPER Labs OU, may from time to time revise this White Paper in any respect without notice. The information presented in this White Paper is indicative only and is not legally binding on NPER Labs OU, or any other party. This document is for informational purposes only and does not constitute and is not intended to be an offer to sell, a solicitation of an offer to buy, or a recommendation of: (1) NPER Tokens, (2) an investment in the NPER Platform or any project or property of NPER Labs OU., or (3) shares or other securities in NPER Labs OU, or any affiliated or associated company in any jurisdiction. Please read the important legal disclaimers at the end of this White Paper.

CONTENTS

1	Abstract	4
2	IP Market Problem	
	2-1. Irrational Distribution Structure	5
	2-2. Becoming Premium Industry	6
	2-3. Opaque IP information & Chain of Title	7
3	Solution with Blockchain	
	3-1. Developing Global IP Peer to Peer Trade Platform	9
	3-2. Building NPER IP Community	10
	3-3. Tokenization of Each IP	11
	3-4. Building NPER IP Distributed Ledger	13
4	Consensus Algorithm	
	4-1. Proof of Stake (PoS)	14
	4-2. Proof of Participation (PoP)	14
5	Token Ecosystem	
	5-1. Building Community Participation System	16
	5-2. Airdrop from Reward for Participation in Community	16
	5-3. Making Transaction for IP Distributed Ledger	17
	5-4. Issuing Special Token with Side Chain	18
	5-5. NPER Global IP Peer to Peer Platform Network FEE	19
6	NPER ROADMAP	20
7	Token Distribution & Use of Funds	21
8	MEMBER	22

“

The best way to predict the futuer, is to create it.

- Peter Drucker -

”

Terms

- **IntellectualProperty=IP**=means thecopyrightofindustrialpropertyrights suchashuman knowledge based invention,trademark, music,literature, art works and etc.

- **Copyrights** = This concept is a subordinate of intellectual property rights, which means the rights of the creatorregarding music, literature and art works.

1. Abstract

Digitalized information processing technology has developed repeatedly overtimes. The rapid development of Information Technology (IT) has transformed our life style more rapidly and many of the existing businesses are facing a problem of survival consequently. The financial sector threatened by Fin-Tech is a representative example. The financial sector has already built a convenient computational mechanism that did not make any big progress on great changes over the past few years. Such mechanism which was established in the 20th century seems almost the same as the mechanism in the 21st century. As a result, such a slow transfer system and excessive fees could be typical problems that have been left for many years. Fin-Tech companies have emerged to solve this problem and are making an existing financial industry be placed at the crossroads of survival. Despite the tremendous developing pace of technology, there exists some industries that do not follow the pace of technology for several reasons. In addition to the financial industry, the intellectual property (IP) industry is another example.

Especially in the IP industry, the copyright market is growing every year, but the creators are not getting the right properly. While IP industry can create dozens of values, IP industry's old infrastructure is making many problem. NPER builds its own blockchain protocol and introduces side-

Function Category	Expandability	Professional Developers	Getting rid of IP Premium	Offline Service
NPER Projects	○	○	○	○
	Building a blockchain protocol for universal use in the IP industry, not limited functions and restricted attempts, with simple DAPP construction	5 professional developers from SAMSUNG Electronics development & research team, CTO from NEXTEL with 20 years of experience on development	Establish a community-participatory IP ecosystem that anyone can easily participate in, thereby eliminating the high premium of the IP industry	Some procedures of IP transfer will be guided by building up global legal partners
Other Copyright / Blockchain projects	✕	△	✕	✕
	Other projects, which are built as Ethereum or Qtum based dApp, are more likely to face the limit of expandability due to problems with fees.	Most of the projects have only few professional developers	Construction of dApp, which is focusing on simple functions rather than establish a community-participatory ecosystem	Unsecured service offering after the trading transaction is over

chain technology to the protocol to solve problems with commission fee and expandability. In addition to PoS (Proof of Stake) consensus algorithm, NPER establish a community-participatory blockchain based IP ecosystem by introducing PoV (Proof of Voting) algorithm, which is able to give community contributors more opportunity to generate block. NPER allows nodes not only to generate blocks but also to actively participate in community and lead ecosystem.

2. IP Market Problem

2-1. Irrational Distribution Structure

The Berne Convention¹ has created a social consensus around the world to protect copyrights which is included in the intellectual property. Many laws and institutions were created and the creators were protected at some point. However, despite of Berne Conventions, no practical structure has been created for creators to legitimately receive or claim a fair price. The music copyrights industry, where the rights of the creators are not protected, exemplifies one of the biggest problem in copyrights market. There is a British musician named Jon Hopkins. He composed the music "Light Through The Veins," which features the introduction of the song "Life in Technicolor" by the band Coldplay. There is a famous tweet message where he tweeted "Got paid £8 for 90.000 plays." This clearly shows the reality of the copyrights industry. Although he is a well-known artist who has been involved in Coldplay's album, he ended up earning 10\$.

Music Streaming Revenue Distribution Structure	
Streaming Company	40%
Records Company	44%
Song Composer·Arranger	10%
Singer·Performer	6%

Data :Ministry of Culture, Sports and Tourism

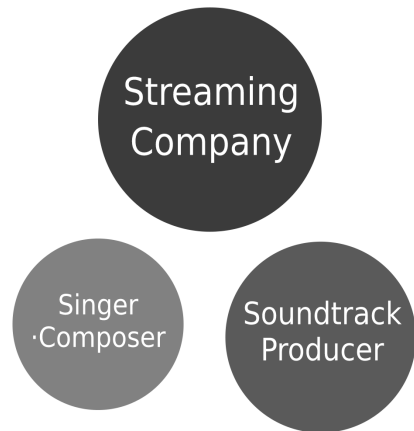

< feature 2 : Distribution of Music streaming Profit in Korea >

It is not just about the music copyrights industry. The publishing industry is in a similar situation. Direct royalties of book sales to the writers are also unusual. If an author sells a book, the profit that goes back to the writer will vary depend on the contract, but the average profit that writers can earn in Korean publishing industry is less than 10%. Not just in Korea, but almost all the categories of copyrights industries in the world are facing the same problems. You can guess why copyright royalties have become hotter issue worldwide. If we only think of this unreasonable structure as a barrier to the copyrights industry, nothing will change. Someone should suggest and find the alternatives solutions. To protect the legitimate rights of creators, NPER builds a global peer-to-peer intellectual property trade platform that has not previously existed by using blockchain. There are some websites that handle and intermediate B2C works such as fonts, images and videos. However,

these websites have some drawbacks such as tremendous transit fee and unreasonable cash flow. (In case of a large agency, money can be tied up for 1~2 months and even a financial investment can be done with these money)

2-2. Becoming Premium Industry

IP continuously creates its new categories as technology develops and new industries emerge. According to WIPO3, the copyrights industry takes an average of 5.69% of GDP of the world's top 40 countries. It is a large-scale number that can not be converted to the exact amount and in the US, where has the most developed copyrights industry, there is about 1,200 trillion Korean won in 2017. However, the majority of IPs remain only at the potential stage and are not properly valued. This is because only a small number of people evaluate and utilize the value of the IP market due to its premium.

	KOREA	CANADA	USA	COLOMBIA	BULGARIA	UKRAINE	SINGAPORE
	0.1B US\$		0.1B US\$	0.1B US\$	0.1B US\$	0.1B US\$	0.1B US\$
Core Copyright	539.9841	—	12,314	57.48	10.67	16,916	105.7722
GDP	15,297	—	193,621	3,074	559	1,040	3,057
Core Copyright / GDP	3.53%	3.33%	6.36%	1.87%	1.91%	1.54%	3.46%
Total Copyright	1,803.5136	—	21,337	102.67	19.118	29.64	189.2288
GDP	15,297	—	193,621	3,074	559	1,040	3,057
Total Copyright / GDP	11.79%	4.50%	11.02%	3.34%	3.42%	2.85%	6.19%

Data : Reports by countries from <WIPO Creative Industry: Economic Contribution & Mapping>

< feature 3 : Contribution of Copyright to GDP >¹

We should create a chance to decentralize such large valuable market and open up the opportunities for the everyone to participate in the IP market. This lowers market premium and allows potential IP to be evaluated properly.

Combining blockchain technology, which will lead the 4th Industrial Revolution and smart contract into IP industry can easily extend the opportunity to participate in this tremendous market. NPER establishes a global IP ecosystem where many people can participate not market that is evaluated by small number of premium.

1. Refer to the reports by countries 'WIPO Creative Industry: Economic Contribution & Mapping'

2-3. Opaque IP information & Chain of Title

Building the IP public ledger dramatically reduces the time and cost for Chain of Title by allowing users to record more detailed information other than general information. For example, a screenwriter writes scripts and owns copyrights to them. Therefore, in order to make a movie based on that scripts, the certificate of rights to script must be contracted with the screenwriter. Providing information of rights holders and their rights by building IP public ledger, you can solve the enormous amount of time and cost for Chain of Title.

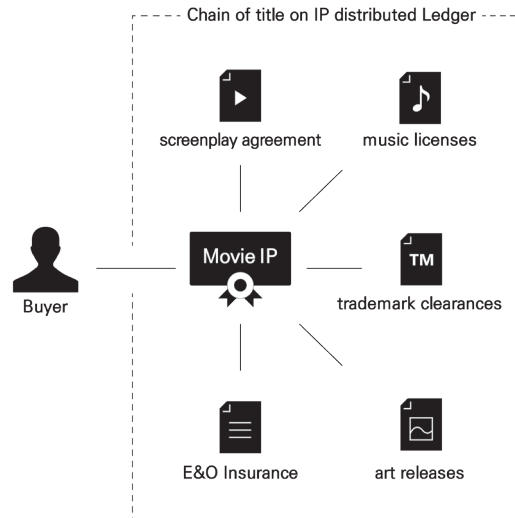

Chain of title may include:

- The interested parties involved in the IP transaction
- Whether IP transactions require the consent from the interested parties
- Current licensing status
- Contents of product's trademark rights
- Information on the location such as where it the force of law has, the location of the registered jurisdiction, and etc.
- E&O Insurance (Errors and Omission Insurance) provides creators with insurance for omission from chain of title. Whether it has E&O Insurance.

When we register IP ownership / user license on distributed ledger and accumulate data, we can save the time and cost and construct IP information system.

In addition to IP information registered on multiple channels, it allows people around the world to register their IPs, they created. Since then, data such as secondary products derived from their IPs are added to create an 'IP Genome Map'. This establish the Chain of Title for IP ownership / user license.

3. Solution With Blockchain

Transparency of Blockchain and Stability Against Hacking

One of the key points of the blockchain technology is that it has decentralized nodes just like account books. This shows the advantages that existing centralized systems do not have.

First is transparency. Blockchain keeps all the information of the wallets involved in the transaction as blockchain books, so it is possible to track how much is left in a certain wallet at any given time. This means that it is possible to prove the transparency of share calculation based on NPER coin holdings and compensation.

Second advantage is stability against hacking. NPER coin transaction details are stored continuously on the blockchain network. This does not simply mean to merely accumulate the transactions details, but also manage the transaction details by combining them into a single encrypted block. Therefore, in order to change the previous transaction details, it is necessary to recreate a block after that transaction. Even if such a hacked blockchain book is made, the block is discarded by the consensus algorithm of the blockchain. Therefore, there is no malicious change within the existing transactions. Based on these features, the NPER platform ensures transparent reward and secure transaction management for users.

Smart Contract that Forces 'Execution' rather than a Mere Contractual Relationships

Smart contracts eliminate the needs of trust among the trading partners. The current juridical interpretation explicitly listed the interests of the parties, but did not enforce the transaction. The blockchain technology with smart contract goes one step further to enforce the contract immediately. Thus, through the system that forces the transaction, the intermediators who take excessive brokerage fees between the trading partners are eliminated. The use of blockchains and smart contracts enables a variety of attempts in the IP industry. It is possible to have direct match between the creator and the user, therefore eliminating the excessive brokerage fees taken by the distributors. In addition, by recording the IP distribution structure in the chain in realtime, the possibility of illegal use of IP can be greatly prevented. And there are many other attempts in the IP industry. The introduction of blockchain solutions in the IP industry can create a huge wave that changes the industry structure itself.

3-1. Developing Global Peer to Peer IP Trade Platform for Creators

When a seller listed the IP at the global peer-to-peer intellectual property platform, a smart contract for the intellectual property rights is created. The intellectual property information and the seller information are stored in the smart contract and NPER token allows the purchaser to easily purchase the IP. In NPER, smart contract for each intellectual property rights is created and stored in a distributed DB, so not only the information of buyers and sellers are directly stored, but also the token is automatically delivered to the seller. This occurs IP trading without middleman. In the meantime, the enormous commissions that have been introduced in IP transactions have been reduced, and IP transactions can be expanded on global channels, not just in one country. It will save huge amount of fees that IP trading generates so far, and IP trading can be expanded on global channels, not just in one country

Comprehensive information that will be contained in smart contract in IP trading will be discussed with experts to build a certain standardized smart contract

Due to the characteristic of IP trading, other legal details are likely to be written, so there is little possibility of unconditional standardization of smart contract.

IP transaction information is stored in the decentralized NPER node DB in order to safely store interpersonal trading information

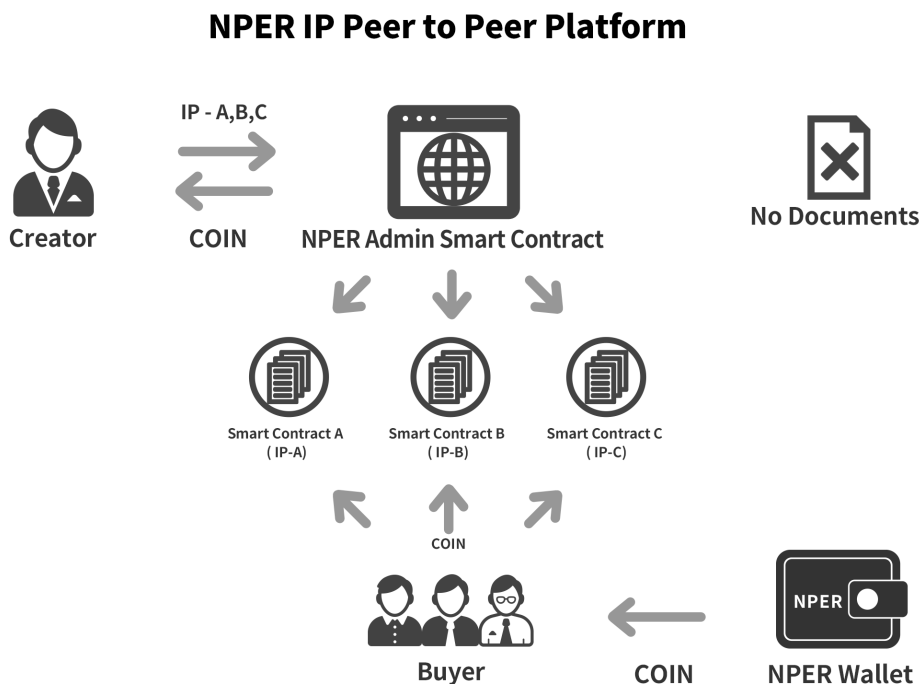

Method on confirming registration on blockchain and transferring token when selling IP

```
function boolean regGoods(Address_owner, long_goods) { if(isCopyright_owner, _goods) {return isSuccess} else{return isSuccess}}  
function boolean transfer(Address_to, Address_from, uint256_value) (return isSuccess)
```

As the rights of creators are not recognized well within the IP industry, the impact of personal media is getting stronger. Artists are gradually experiencing more of the irrationality and illogicality from a large company as a channel of distribution and publicity than its benefits. Based on this social consensus of the artists and as NPER global IP rights peer-to-peer transaction structure gradually gains more marketing power, there will be more artists eager to sell their works on NPER platform. If the function of a marketing channel works well enough, the competition between NPER and large copyrights companies as a platform will be possible in a long-term.

3-2. Building NPER IP community

Establish NPER community within the NPER ecosystem that is open to participation by all. Through this, community members will evaluate various IPs. Participation of NPER community members allows the sharing of general information and opinions about IP. Through these community activities, we find undervalued IPs and support creators who have the ability but lack the economic power to create.

IP is purchased directly from NPER at some cost so that community members can actively participate in the ecosystem. This allows airdrop of tokens to active ecosystem contributors whom for example post comments concerning IP. It also allows ecosystem contributors to get continuous NPER token incentives in addition to block creation.

Airdrop serves to encourage users to actively participate in the ecosystem. But Airdrop is not for everyone. Users only who participate in community activities, such as posting comments and reporting inappropriate postings, are encouraged by the PoP (Proof of Participation) algorithm.

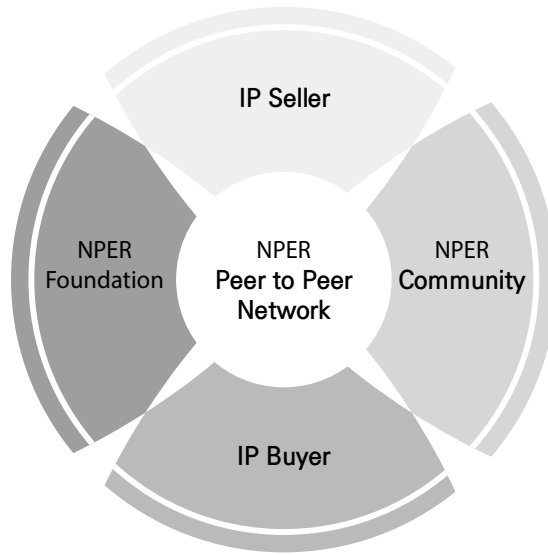

〈 Feature 5 : NPER IP Peer to Peer Trading Platform 〉

Those who participate in the community activity with NPER Coin holding in their NPER wallet will receive the NPER Coin Airdrop in reward for community participation. All Airdrop procedures are transparent and proceed in proportion to individual community involvement.

NPER Wallet will be used to prove the stake(PoS) in peer-to-peer transactions. Afterwards, compensation for participation in community will be Airdropped with NPER coin in NPER Wallet Account based on records of contribution and participation to community.

This IP community will draw the general public's interest on IP industry, which will allow many people to take the premium of IP markets that only few people have monopolized. It also plays an important role in the ecosystem so that more people can easily access to the IP market.

3-3. Tokenization of Each IP

Individual "IP" is issued as a special token within the side chain, enabling specific IPs to be traded by Peer to Peer. In addition, with the tokenized individual IPs, anyone can easily purchase promising IP in a form of token. It is also connected to the NPER community and it enables the purchase of individual IPs that are tokenized with NPER coins. (However, Special token for a particular IP generated within the side chain is unable to trade in the exchange.) Below is how NPER manages the token.

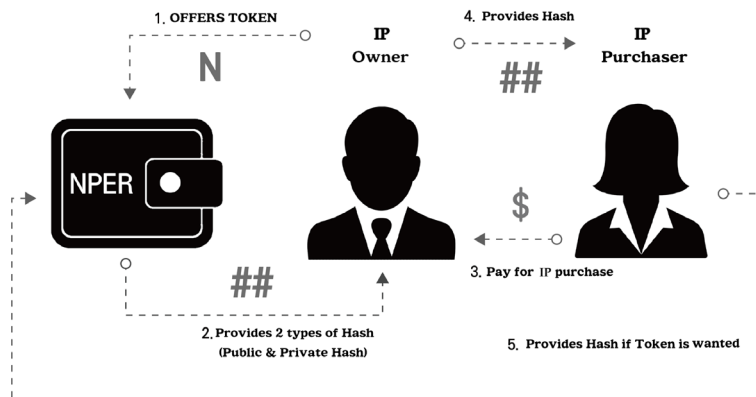

< Feature 6 : The method of manage Certain Tokenized IP >

NPER coin holders create wallets for specific IP tokens they have. There are two types of Key: Public Key / Private Key. Issued Public Key is registered on the NPER blockchain and the Private Key is encrypted and registered once again. By searching Public Key on the NPER blockchain, the coin holder can prove to everyone that he/she owns the Certain IP coin.

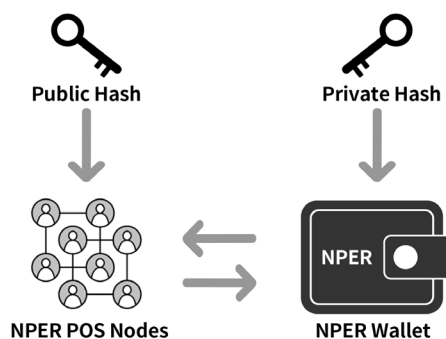

< Feature 7 : Public Hash & Private Hash >

Token owners of a tokenized particular IP can freely trade between accounts within NPER. At this point, the purchaser of a specific IP token searches Public Key on the NPER Block chain. This allows you to identify who owns the particular IP token in the ledger. If you want to make an offline transaction, you can take over the private key and send the token to another address.

Method on checking data such as the status of my reward (reward), the number of tokens currently held, etc.

```
function boolean checkTokenAmount(uint256 _goodsValue, uint256 _tokenValue) (return isSame)
```

Method on regularly rewarding (rewarding) royalties to coin owners for voting participation

```
void periodicallyReward(Address[] _to, uint256 _reward) {}
```

3-4. NPER IP Distributed Ledger

The NPER IP distributed ledger solves the time and cost issue of entering the Chain of Title, which has been one of the chronic problems of the IP industry. Chain of Title usually occurs during IP trading, but it is very expensive and time consuming for IP trading because of its ambiguity. Also, NPER IP distributed Ledger will be used to record the second and third works derived from the relevant IP, to draw up the IP genome map, and ensure that the information is notarized by all. Anyone can be authenticated to all of their own IPs with just a few clicks.

First, the following IP information will be included through smart contract transmission. But it is not limited to this.

1. **IP Name**
2. **IP Creator**
3. **Creation date**
4. **First IP uploaded URL**
5. **Date of change in licenses/ownership**

Based on this transmitted information, Genesis IP Block will be created. The Genesis IP Block will be created and information on the Smart Contract will be available. When various creations are derived from the first IP, the 'IP genome map' is created in conjunction with the corresponding Genesis IP Block.

The creation of an IP distributed ledger reduces the time and expense of the Chain of Title, makes the ownership of IP clear, and protects the secondary creations that can not be protected by law. The IP distributed ledger make it easy for anyone around the world to gain recognition without going through many formalities. In the beginning, however, a centralized organization will intervene to prevent reckless registration and will slowly expand the authority of the community.

4.Consensus Algorithm

4-1. Poof of Stake

The consensus algorithm for the block generation of the NPER chain proceeds with POS (equity verification method). The node has the opportunity to participate in the block creation in proportion to the NPER coin ownership held by the NPER wallet. Therefore, the higher the stake ratio, the greater the contribution to block generation and the greater the incentive compensation for block generation.

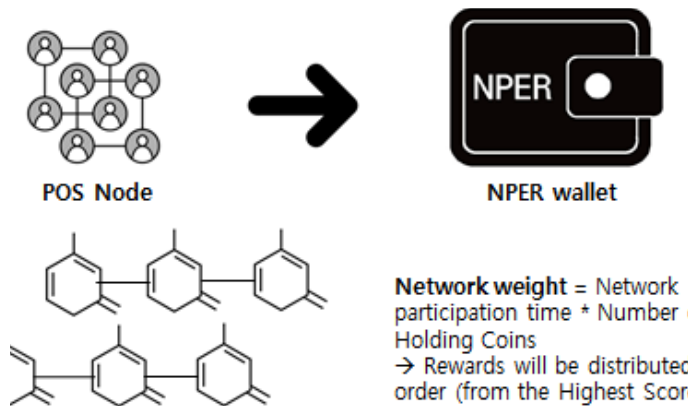

The initial NPER coin issuance is 250,000,000 and after the main network construction is completed, an incentive is given to the node.

In the NPER main network, a node that participates in the POS method and generates a block is rewarded by the network weight.

$$\text{Network Weight} = \text{Network Participation Time} * \text{Number of Coins You Have}$$

4-2. PoP (Proof of Participation)

To activate NPER's IP community, the PoP algorithm is constructed with the PoS algorithm. PoP provides network weights, that gives priority in participation of block generation, to active nodes in the NPER IP community. This weight is added to the network weight of PoS and reflected in block generation. In other words, if the PoS is similar, the more active the nodes are in the IP community, the higher the network weight reflected in the PoP, the greater the probability of generating blocks. In the existing PoS method, it is not reflected in block generation based only on the number of coin

holdings and network participation time. By using PoS and PoP, it increases the number of nodes participating in the community ecosystem and provide incentives to participate continuously.



5. Token Ecosystem

5-1. Participatory Compensation system in PoP Algorithm

Application of Participatory Compensation system will increase interest in the IP industry and encourage active participation of the community members. As the IP industry is continuously growing, the premiums in the industry are also steadily increasing. To create an ecosystem that eliminates the premium of the IP industry that creates very high added-values and share its values, active participation from the public is required.

Participatory Compensation System plays the following roles in the NPER IP ecosystem.

1. A function that allows anyone to easily express subjective opinions about IP
2. A figure that demonstrates the active activity of community users and links them to the PoV algorithm
3. Basis for Airdrop for Active participation of the nodes.

Once IP information is registered within the NPER ecosystem, users can freely share their opinions on the IP, and recommend the IP through comments.

The factors to consider before introducing the participatory compensation system are the abusive behavior. Compensation will be greatly lowered when the activity score of an account, linked to PoP to prevent abusive behavior, reaches a certain point.

5-2. Airdrop from Reward for Participation in Community

NPER uses portion of funds for the purpose of purchasing IP. In addition to creating blocks for community participants through IP purchases, Token Airdrops will take place to encourage community participation.

IP purchases are accessible from two perspectives.

1. Rental purchase or purchase of IP that creates steady royalties
2. Potential IP that are likely to generate added value

Let's say there is a work called A which earns an average of 500 million won a year. If the copyright owner holds the copyright of A for five years, the royalty revenues after five years will be about 2.5 billion won. Copyright Merchants may sell copyrights at a lump sum for royalties to money financing for the creation of other works.

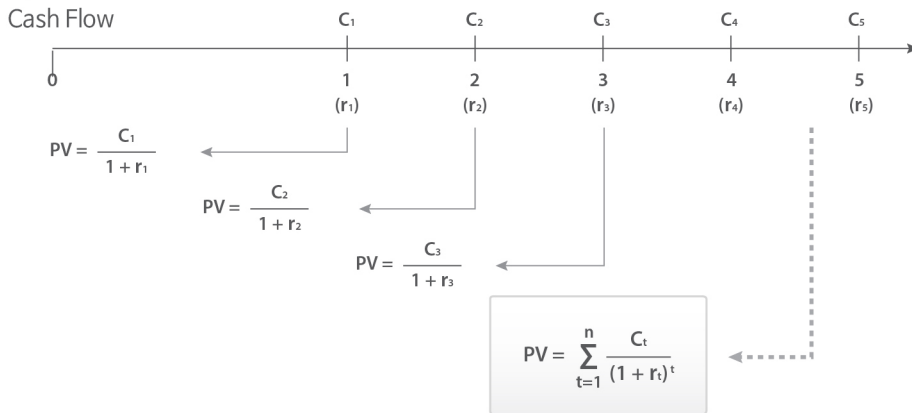

〈 Feature 9 : Present value & Future value of Cashflow 〉

*** PV = Present Value of Future Money,**
Cn = Value of current money n years later, rn = Market interest rate in n years

Let's take an example of David Bowie, which was a real music copyright trading case. Prudential bought a 10 – year royalty for 300 songs from David Bowie for \$ 55 million. The copyrights were issued and generated earnings of \$ 4.4 million a year. It is difficult to predict exactly how much Prudential has valued the copyright royalties of Bowie for 10 years. It can be estimated range from approximately \$ 77 million to \$ 90 million.

5-3. Chain of Title on IP Distributed Ledger

The creator or IP holder transmits information of Chain of Title to smart contract of NPER blockchain. To prevent DDOS attack and indiscriminate registration certain amount of NPER will be charged for commission.

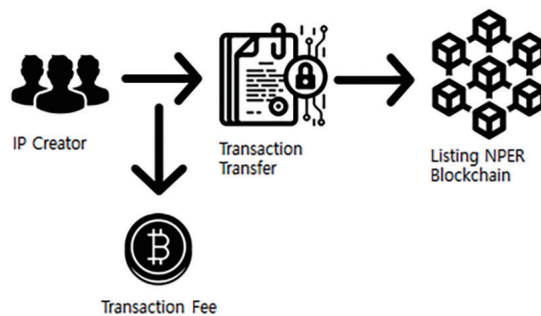

〈 Feature 10 : transfer IP Information in Transaction 〉

Transaction Fee will be returned to Block Creation Node and portion will be stored in the Reserve Pool for Voting Incentives. Transaction Fee will also be charged when continuous addition to creations are derived after the initial IP registration on NPER Blockchain. The rational number of tokens for Transaction Fee will be determined after the ongoing test.

5-4. Issuing IP Token with Side Chain

NPER will issue a token for individual IP in the side chain, not in the NPER main chain. No transaction will be made outside NPER main network because it is issued by the side chain rather than the main chain. (Individual IP tokens differ from NPER coin value as they are not available for trade on external exchanges.)

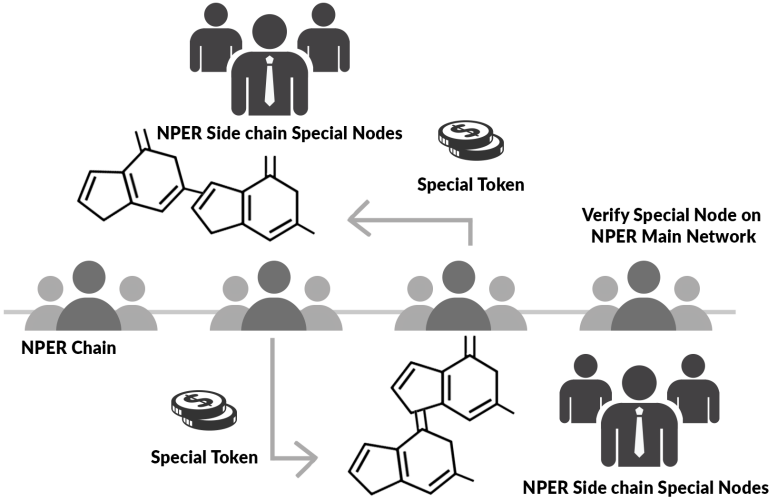

< Feature 11 : Tokenize IP in Sidechain >

Anyone can easily buy and sell IP token, tokenized individual IP on side chain. Submission of NPER, as commission, is required for closing and creating transaction. Tokenized individual IP can be stored in NPER Wallet but impossible to withdraw to outside sources. Unconstrained IP token transaction will increase the possibility of IP commercialization.

In order to have legal effect on the transaction, the current actively discussed law issue on smart contract must be solved. If the Smart Contract is legally valid by global agreement, there is a high possibility that an active market will open but in the opposite situation it will be a pointless model. Positive result is expected as there are active discussions about Blockchain and Smart Contracts.

Method on selling copyright through auction and checking whether the product is registered through blockchain

```
function boolean regGoods(Address _owner, long _goods, @Nullable Option _auction) { if (isCopyright(_owner, _goods)) { return isSuccess } else { return isSuccess } }
```

5-5. NPER Global IP Peer to Peer Platform Network FEE

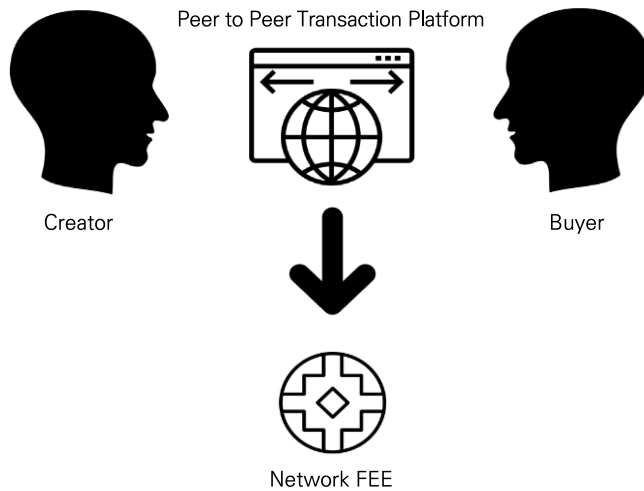

< Feature 12 : NPER IP Trading Platform Network FEE >

All exchange users conduct transactions in NPER coin, Ethereum and Bitcoin on the NPER platform. A conduction of Peer-to-Peer IP transactions generates commission fee depending on the amount of transaction cost is occurred. At this time, small amount of transaction commission fee is charged when using the NPER coin, but larger amount of commission will be charged if you use Ethereum or Bitcoin. This removes the excess brokerage fees traditionally owned by the copyrighted work. This fee is used to support off-line services for platform maintenance costs and copyright transfer procedures for Peer-to-Peer traders' countries.

It does not mean that the termination of a transaction on IP at NPER 's global Peer-to-Peer exchange makes the termination on all of the procedures. Because there are some countries which require an administrative process on transferring the ownership of the works, when there occurs a Peer-to-Peer ownership transaction. Other projects do not consider these post-process, but NPER will support some of the administrative procedures for each country as an off-line service in the future.

6. NPER ROADMAP

2017 Q4

- Testnet Deployment
- MOU with BitBank
- Cooperation with Hexlant
- NPER Token Issue
- Pre-sale

2018 Q1

- DAPP Web/iOS/Android Prototype Development
- Crowd Sale
- NPER Wallet Development
- Listed on Exchange
- NCC(NPER Copyright Consortium) Open

Q2

- NPER Android Wallet Beta Release
- Purchase IP(Intellectual Property)
- NPER IP Distributed Ledger Prototype
- NCC Network Construction

Q3

- NPER iOS/Web Wallet Beta Release
- IP Investment Expansion
- IP Distributed Ledger Beta Release

Q4

- Proof of Participation Algorithm Development
- NPER Air Drop
- NCC Conference
- IP Special Token Issue

2019 Q1

- Testnet Launch
- Support Creators
- Block Explorer Release
- JSON RPC API Release

Q2~Q3

- Core Wallet Release
- Decentralized IP Exchange Release
- Proof of Stake(PoS) on Testnet Start
- Extend IP Business Model

Q4

- NPER Mainnet Launch

7. Token Distribution & Use of Funds

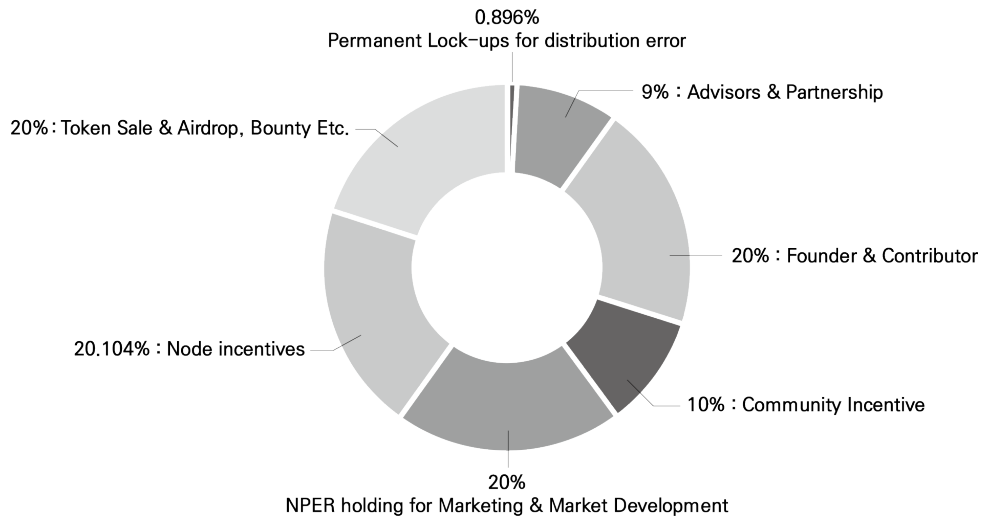

Total Volume : 250,000,000 NPER / 1ETH = 5,000 NPER / Presale = 10% Sale with 15% NPER Bonus
 Crowdsale = 10% Sale with No Bonus / Hardcap = 10,000 ETH

Use of Funds

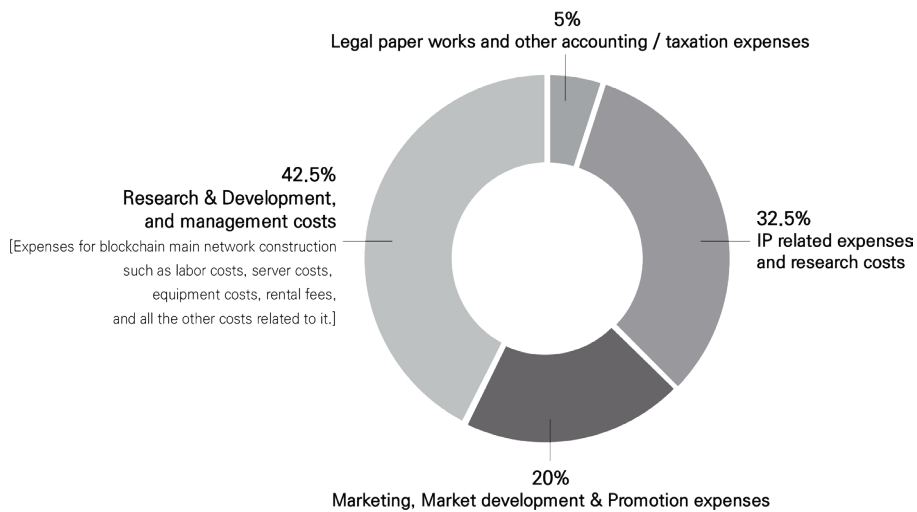

8. MEMBER

- **CEO – Daniel Nam** : As a general manager and operation planner, he has accumulated project planning and operating experience at Hyundai Motor Group. He was the youngest Entrepreneurship Division leader in multinational NGOs and also contributed to the founding of third-country and developing country towns. He has served as the chairman of the Global Social Business NPO and has won many awards for domestic and international business idea competitions.
- **COO– Ryan Kim** : He is a service planner and general manager of this project. He majored in Germanistik and business administration at University and worked at securities firm to develop sales and investment planning ability. In 2012, he introduced the talent donation project, which was an unfamiliar concept in Korea and received the attention of the media and received a congratulatory speech from the Minister of Health and Welfare.
- **CTO & S/W Engineer – Mike Lee** : He developed large capacity data collection and analysis service at the government of the Republic of Korea. Since the early days of the Internet, he worked at WEB-International and Nextel New Media Research Institute and developed various services related to large-volume data collection and analysis. He developed Remote Mining Management of cryptocurrency Web and also developed and distributed various web and PC programs.
- **CDO – Johnny Lee** : As a marketing planner and copywriter, he had marketing experience with LOTTE Group and Japan Dentsu subsidiary, planning IBK Industrial Bank, Daewoo Securities, Samsung Life Insurance, Gucci, etc. Planning, marketing and selling of social matching services and has planned and operated about 1 million fans' SNS channels and 500,000 users' vertical community services
- **Design Manger – Danny Park** : As a senior designer of NPER, he is responsible for Art-Directing and design works. He has experience in UI and brand management of various Internet and mobile services. He has accumulated experience in visual strategy of consumer-contacting-points through his experience in advertisement design and planning of various projects such as HyundaiCard, KEB Hana Bank, SK Lubricants and KT.
- **S/W Engineer & Blockchain core DEV – Alex Park** : He participated in DB Security and Hadoop security project at Samsung Software Center Security Lab. also have experienced numerous security issues and distributed server DB building through many web projects for 10 years. Currently, constructing a number of cryptocurrency nodes such as Bitcoin, Ethereum, and Litecoin, and developing the exchange. He is responsible for the development of smart contracts and will lead the construction of the main network of the project.
- **Full stack DEV – Henry Kang** : He has developed a web front & back-end service with more than 100,000 hardware nodes at Samsung Electronics and earned a professional grade in algorithms. He also joined Water Bear Software as a founding member. Then he studied hardware communication technology such as ZIGBEE and BLE at Korea Electronic Components Research Institute (KETI). He also joined 'Buildit' as a CTO, led the web and app development of the company as a whole.
- **S/W Engineer & Researcher – Jason Lee** : He participated in the implementation of Tizen OS algorithms at Samsung. He has worked on Samsung Software Center and has accumulated various artificial intelligence and platform development experiences. At Korea Electronics Technology Institute (KETI) he invented the image signal processing algorithm. He always has participated in various projects to solve real life problems by software.
- **Blockchain Core DEV – Sam Kim** : He designed the IoT platform based on OneM2M on Hyundai Motor Group, and has participated in Hyundai Capital's next-generation project. Also, worked on a project to visualize the data in the Ministry of Land, The Software Policy & Research Institute (SPRI), and then worked on the IoT build project at the M2M Lab at Purdue University in the United States
- **CMO – Michael Kim** : He is in charge of marketing management of NPER. He was a co-founder, CEO of F&S Trading co, performing marketing, logistics, importing and exporting tasks. He worked for DOOWON system as a marketer, and planner&designer, launching and designing diverse tourism merchandises. He is teamleader of start-up group called Enlight Brothers. He has participated in proofread & publishing of Michelin Green guide's French edition
- **CSO – Laura Park** : She is currently handling community and service management based on those practical work experiences. She can speak fluent English and German as she majored in German language & literature, and psychology. With her enthusiasm on arts and history, she has experience in planning and guiding at museum education research center and Europe museum tour programs. Also, she has experienced winning a grand prize for enterprise analysis competition.
- **Lead CS Manager – Jessie Cho** : As a global marketing manager, she has accumulated re-branding project planning and marketing experience at SK Walkerhill Hotel. She majored in Germanistik/ English Literature and has M.P.H degree from Yonsei University. In addition to her background in various fields she also has experience in global freight start-up.
- **IP Researcher : Sunwoo Kim** : As a Creative Director, he plans and manages services. He majored in Business Administration at Sunkyunkwan University and have held an industry-academic cooperation contest with distribution industry and three universities. He worked in consulting and M&A team of accounting firm KMPG to develop planning, management and sales ability.

Notice & Caution – (TBD)

The NPER project white paper is written to explain the project's overall contents and roadmap. This white paper is not meant to be an invitation to participate and anyone who reads this white paper will be liable to NPER LabsOU. for any damages, losses, debts or other financial damages arising from this white paper. Please note that we are not in charge of any indemnification, compensation or other liability. Please note that NPER Labs OU. shall not be responsible for any financial damages and debts caused by personal acts like decision-making based on making use of this white paper (not limited to referring to or basing on)

This white paper of the NPER project is written based on "as is" at the time of writing, hence nothing contained in the white paper is guaranteed to be accurate or be unchangeable to the future.

NPER Labs OU. makes no representations or warranties to anyone reading this white paper with respect to this white paper and assumes no legal responsibility for it. For example, NPER LabsOU. do not guarantee whether this white paper based on legitimate rights, whether it violates third party rights, whether it is commercially valuable or useful and whether there are errors on the white paper. The scope of exemption from liability is not limited to the example mentioned.

Reference

<https://www.coindesk.com/information/ethereum-smart-contracts-work/>

<https://blockgeeks.com/guides/smart-contracts/>

<https://github.com/ethereum/go-ethereum>

<https://blockgeeks.com/guides/what-is-blockchain-technology/>

<https://media.readthedocs.org/pdf/solidity/develop/solidity.pdf>

<https://blockgeeks.com/guides/smart-contracts/>

<https://medium.com/startup-grind/gentle-intro-to-blockchain-and-smart-contracts-part-1-3328afca62ab>

<https://github.com/CappasityTech/ARToken/tree/master/contracts>

<https://blockgeeks.com/guides/proof-of-work-vs-proof-of-stake/>

<https://github.com/ethereum/wiki/wiki/Proof-of-Stake-FAQ>

<https://hackernoon.com/is-proof-of-stake-really-the-solution-2db68487f4ba>

<https://docs.decred.org/mining/proof-of-stake/>

<https://blockchainhub.net/blockchains-and-distributed-ledger-technologies-in-general/>

<https://keepingstock.net/explaining-blockchain-how-proof-of-work-enables-trustless-consensus-2abed27f0845>

<https://github.com/ethereum/solidity-test-bytecode>

<https://github.com/ethereum/meteor-dapp-wallet/commit/24c1602b6731d095afbd76fbbac135ffb627dc53>

<https://github.com/ethereum/simplecasper/commit/7cc6f6d0108502c25a94f732fca3f1d42f091f93>

<https://github.com/ethereum/test-tools/commit/92790e8fcd8586a8e92a360be321163eb1a8ef7e>

